

ORAC<sup>®</sup>  
DECOR



*Reflecting*  
your  
*Imagination*

# Welcome to our World of Imagination



*[Handwritten signature]*

*[Handwritten signature]*

nl

Welkom in de droomwereld van ORAC<sup>®</sup>

Orac<sup>®</sup> is dé internationale referentie voor hoogkwalitatieve 3D-ornamenten, die permanent innoveert op het vlak van technologie, materialen en design. Het resultaat is een complete collectie gemaakt door en voor gepassioneerde vaklui. Professionals met een creatieve geest die houden van innovatieve en gemakkelijk te installeren kwaliteitsproducten, om inspirerende en unieke ruimtes te creëren. Van plinten en indirecte verlichtingsprofielen over multifunctionele profielen tot kroonlijsten met karakter. Eigentijdse kwaliteitsoplossingen, functioneel én decoratief.

Met Orac<sup>®</sup> maakt u van elke ruimte iets unieks. Helemaal in lijn met uw stijl en persoonlijkheid, zonder enige creatieve beperking.

Welkom in onze wereld.

fr

Bienvenue dans le monde merveilleux d'ORAC®

Orac® est la référence internationale pour les décorations 3D de grande qualité, innovant en permanence sur les plans de la technologie, des matériaux et du design. Avec pour résultat une collection complète réalisée par et pour des passionnés. Des professionnels à l'esprit créatif, qui aiment les produits de qualité innovants et faciles à installer, pour créer des espaces inspirants et uniques. Des plinthes et profils d'éclairage indirect aux corniches de caractère, en passant par les profils multifonctionnels. Des solutions de qualité actuelles, fonctionnelles et décoratives.

Avec Orac®, vous faites de chaque espace un lieu unique. En parfaite cohérence avec votre style et votre personnalité, sans aucune restriction créative.

Bienvenue dans notre monde.

en

Welcome to the dream world of ORAC®

Orac® is the international standard for quality 3D ornaments, innovating constantly in technology, materials and design. The result is a comprehensive and complete collection by and for passionate professionals. Creative professionals who appreciate innovation and quality products that are easy to install, enabling them to create inspiring and unique spaces. From skirting boards and indirect lighting profiles to multifunctional profiles and cornice mouldings with real character. Contemporary quality solutions that are both functional and decorative.

With Orac® you can make every room unique, entirely in line with your style and personality, without any creative restrictions.

Welcome to our world.

de

Willkommen in der Traumwelt von ORAC®

Orac® setzt international Maßstäbe für qualitativ hochwertige 3D-Ornamente. Das Unternehmen schafft unablässig Innovationen bei Technologie, Materialien und Design. Leidenschaftliche Spezialisten entwerfen eine Kollektion für ebensolche Kunden. Kreative Fachleute, die Innovationen und leicht zu installierende Qualitätsprodukte zu schätzen wissen, um inspirierende und einzigartige Räume zu schaffen. Von Fußleisten und Leisten für die indirekte Beleuchtung über multifunktionale Leisten bis hin zu Eckleisten mit Charakter. Moderne Qualitätslösungen, funktional und dekorativ.

Mit Orac® machen Sie aus jedem Raum etwas Besonderes. Ganz im Einklang mit Ihrem Stil und Ihrer Persönlichkeit, ohne Einschränkung Ihrer Kreativität.

Willkommen in unserer Welt.

es

Bienvenidos al mundo de los sueños de ORAC®

Orac® es referente internacional para adornos en 3D, siempre desarrollando nuevos procesos aplicando las últimas tecnologías, alta exigencia en la calidad de nuestros productos y diseños innovadores. El resultado es una completa colección diseñada por y para profesionales apasionados, con espíritu creativo y a los que les encantan los productos innovadores y de fácil instalación. Una colección que permite crear espacios inspiradores y únicos: desde zócalos, molduras multifuncionales y perfiles con iluminación indirecta hasta cenefas con carácter. Soluciones modernas y de calidad, funcionales y decorativas.

Con Orac®, convertirá cualquier espacio en algo único. Completamente en línea con su estilo y personalidad, sin límites de creatividad.

Bienvenidos a nuestro mundo.

*Reflecting*  
your  
*Imagination*

ORAC<sup>®</sup>  
DECOR





***Antonio***

Create a Ray of Light

# Our Design Favorites

2003

Myline



C353  
p. 82

Jacques Vergracht

2012

Golf



P3071  
p. 67

Ulf Moritz



2009

Infinity



C990  
p. 88

Xavier Donck

2009

High Heels



SX156  
p. 116

Xavier Donck

2011

Wave



C364  
p. 121

Pierre Daems  
Red Dot Design Award 2014

2012

Scala



G71  
p. 71

Ulf Moritz

2012

Shade



C371  
p. 66

Ulf Moritz

2011

Heritage



C343  
p. 90

Guy Taillieu

2011

Antonio



C374  
p. 68

Ulf Moritz

# Content

**10 Inspiring Interiors**

**62 Product Overview**

64 Ulf Moritz Collection

80 Cornice Mouldings

100 Panel Mouldings

112 Skirting

118 Indirect Lighting

126 Deco Elements

148 Adhesives and Accessories

**154 Project and Exterior Info**

**156 Technical Info**



## nl

Door met eenvoudige, strakke profielen en elementen, grafische lijnen en patronen aan te brengen, wordt het interieur net ietsje spannender in deze Bed & Breakfast. De lichte tinten op de muur en de verhoogde plint, meegeschilderd in de kleur van het parket, tonen het Scandinavië zoals we het kennen: clean, grafisch en stijlvol.

## fr

La mise en place de motifs et de lignes graphiques par le biais d'éléments et de profils épurés et simples confère une dimension supplémentaire à l'intérieur de ce Bed & Breakfast. Les teintes claires sur le mur et la plinthe surélevée dans la salle à manger, peinte dans la couleur du parquet, évoquent la Scandinavie telle que nous la connaissons : pure, graphique et élégante.

## en

Applying simple, straight profiles and elements, graphic lines and patterns gives the interior of this bed and breakfast that extra touch of visual excitement. The light tones on the walls and the high skirting boards in the dining room, painted in the same colour as the wooden floor, give the room a classic Scandinavian ambience: clean, graphic and stylish.

### 1 G77 LILY p. 72

designed by Ulf Moritz



### 2 G78 LILY p. 72

designed by Ulf Moritz

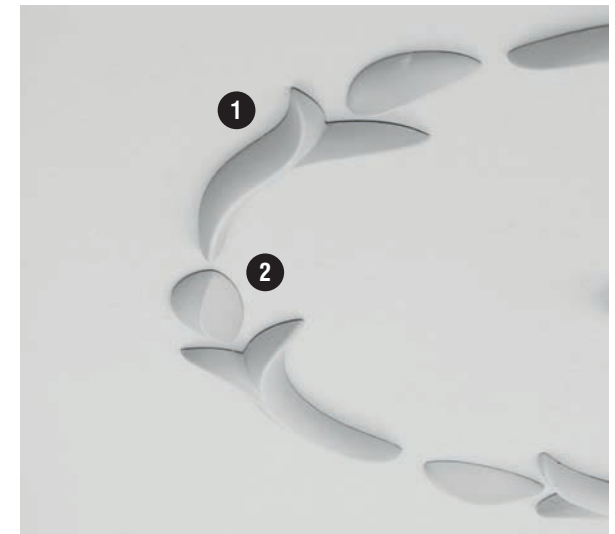

3 CB501 p. 97



4 DX157-2300 p. 114



5 CB503 p. 97



6 PX120 p. 106



7 R66 p. 138



8 DX163-2300 p. 115



9 DX162-2300 p. 106



## de

Die grafischen Linien und Muster, die hier durch einfache, geradlinige Profile und Elemente entstanden sind, verleihen dem Interieur dieses Bed & Breakfast Hotels einen Hauch von Spannung. Mit den hellen Wandfarbtönen und der erhöhten Sockelleiste im Esszimmer, gestaltet in der Farbe des Parketts, präsentiert sich Skandinavien hier, wie wir es kennen: zurückhaltend, grafisch und stilvoll.

## es

El uso de elementos y perfiles sencillos y rectos, así como de patrones y líneas gráficas, proporciona al interior de este hostel ese toque adicional de entusiasmo visual. Los tonos claros de las paredes y de los zócalos altos del comedor, pintados del mismo color que el suelo de madera, dotan a la estancia de un ambiente escandinavo clásico: limpio, gráfico y elegante.

*“Clean, graphic lines – pure Scandinavian style”*

Vemdalen  
— SE

# Hölm





# Hölm





1 R08 *p. 136*







2 CB503 *P. 97*



**Multi-Functionals**

DX157-2300 | DX157F  
 DX162-2300  
 DX163-2300  
 DX168-2300

<p>3 DX157-2300   DX157F <i>p. 107</i></p> 	<p>4 DX162-2300 <i>p. 106</i></p> 
<p>5 DX163-2300 <i>p. 107</i></p> 	<p>DX168-2300 <i>p. 116</i></p> 

# Artson

Cranleigh  
— UK





## nl

De Engelse Heritage wordt in deze kamer op een moderne wijze tot leven gewekt. De kaders op de muur zijn in een origineel patroon geplaatst en de imposante asymmetrische kroonlijst creëert een optische illusie. Een interieur dat laat zien dat groots uitpakken met forse profielen een enorm succes kan zijn.

## fr

Dans cette chambre, l'héritage anglais est ressuscité d'une manière contemporaine. Les cadres sur le mur sont placés dans un motif original et la corniche asymétrique imposante crée une illusion d'optique. Un intérieur qui démontre que créer un effet majestueux avec des profils massifs peut s'avérer une véritable réussite.

## en

English Heritage is recreated in a modern manner in this room. The framed panels on the wall are arranged in an original pattern, and the imposing asymmetrical cornice moulding creates an optical illusion. This interior shows that a grand style with strong mouldings can be enormously successful.

## de

In diesem Zimmer wird ein englisches Denkmal auf moderne Weise zum Leben erweckt. Die Wandrahmen sind in einem originellen Muster angeordnet und die imposante asymmetrische Eckleiste schafft eine optische Täuschung. Eine Einrichtung, die beweist, dass ein üppiger Einsatz von kräftigen Profilen enorm erfolgreich sein kann.

## es

Esta estancia recrea el «patrimonio inglés» desde una perspectiva moderna. Los paneles enmarcados de la pared se han dispuesto siguiendo un patrón original, mientras que la imponente cornisa asimétrica crea una ilusión óptica. Este interior confirma que un magnífico estilo con molduras robustas puede cosechar un gran éxito.

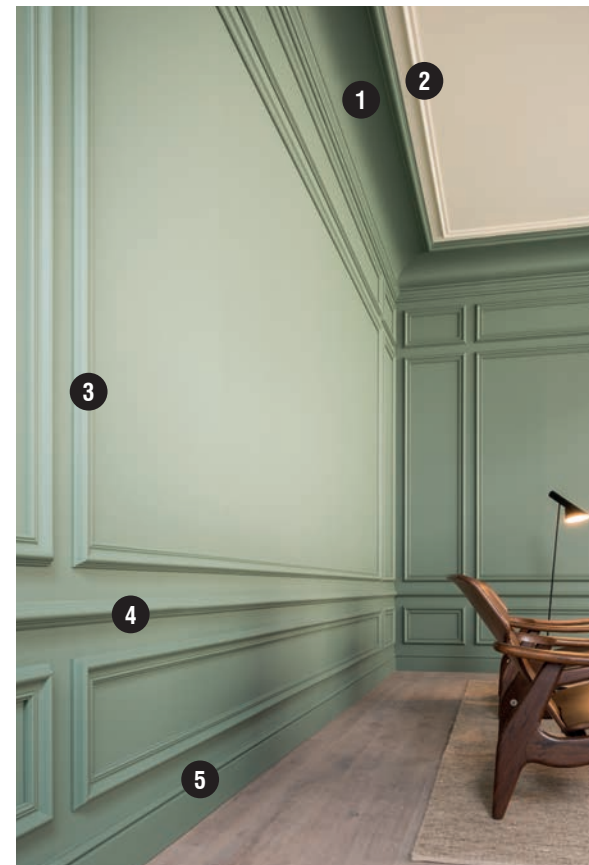

❶ C344 HERITAGE p. 91



❷ P8030 p. 102



❸ P8020 p. 103



❹ P4020 p. 102



❺ SX118 p. 116





1 P8020 p. 103



2 P4020 p. 102



# Artson

*“Grand style:  
a great success”*

C341 M

P. 84

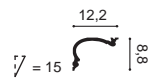

C342 L

P. 87



C343 XL

p. 90

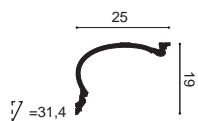

3 C344 XXL

p. 91

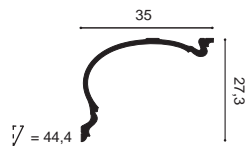

4 DX170-2300

p. 128



5 D330LR

p. 128

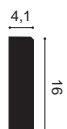

C341 M  
C342 L  
C343 XL  
C344 XXL  
DX170-2300  
D330LR

**The  
Heritage  
Collection**



Das  
**Tegernsee**  
Hotel

1 PX120 p. 106



2 P8020 p. 103



3 PX103 p. 106



4 SX137 p. 115



5 CX124 p. 94

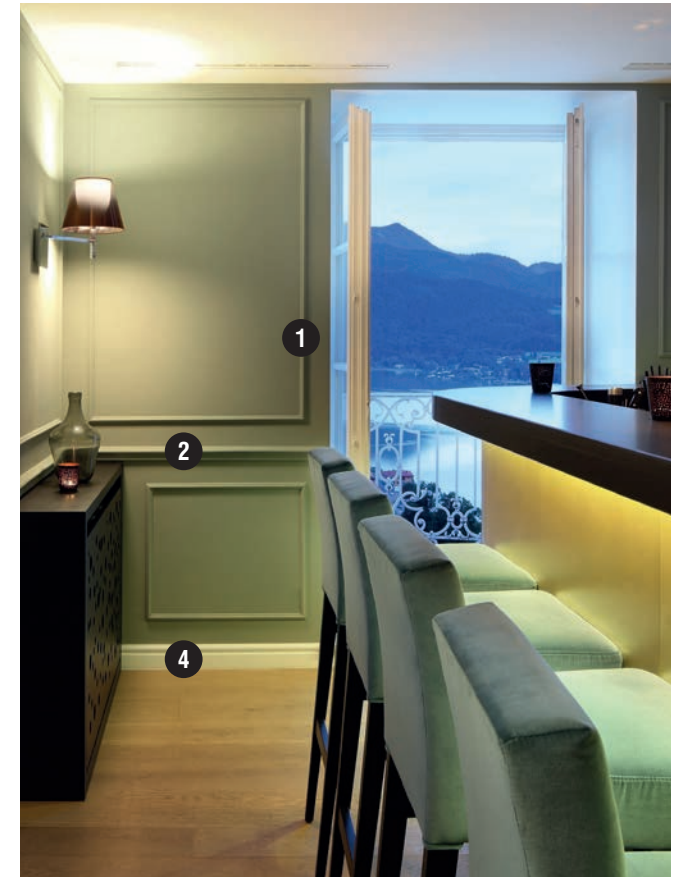

Tegernsee  
— DE

"A room  
with a view"



# Northsea Penthouse

Oostende  
— BE



*“Sometimes it complements the surroundings, sometimes it emphasizes them and sometimes it quietly merges into them – that is the essence of architecture”*

## nl

De rust van de natuur en de zee naar binnen halen, dat was de opdracht. De profielen versterken het interieur zonder op te vallen en de indirecte verlichting geeft een ruim en licht karakter aan dit appartement aan de Belgische kust.

## fr

L'objectif était simple : restituer à l'intérieur l'impression de calme évoqué par la nature et la mer. Les profils renforcent le concept intérieur sans se faire remarquer et l'éclairage indirect confère un caractère spacieux et lumineux à cet appartement situé sur la côte belge.

## en

The task was to bring the restful mood of nature and the seashore inside. The mouldings add to the interior without being conspicuous, and the indirect lighting gives this flat on the Belgian coast a light and roomy feel.

## de

Die Ruhe der Natur und des Meeres ins Haus holen, so lautete die Aufgabe. Die Profile betonen die Einrichtung ohne aufzufallen und die indirekte Beleuchtung schafft einen großzügigen und leichten Charakter in diesem Apartment an der belgischen Küste.

## es

El objetivo era trasladar puertas adentro la paz que uno siente en la naturaleza y a orillas del mar. Las molduras se integran en el interior sin ser apenas perceptibles, mientras que la iluminación indirecta transmite a este piso de la costa belga una sensación de amplitud y claridad.

### 1 C357 STRAIGHT p. 120

designed by  
Jacques Vergara

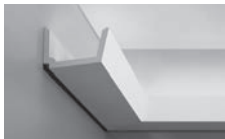

### 2 DX157-2300 p. 114



### 3 C354 p. 82

designed by  
Jacques Vergara



### 4 DX163-2300 p. 115







**1** C990 INFINITY *p. 90*

designed by Xavier Danck



**2** SX156 HIGH HEELS *p. 116*

designed by Xavier Danck



**3** CX126 *p. 95*



**4** C362 CURVE *p. 121*

designed by Pierre Dams



# Northsea Penthouse



Den Haag  
— NL

# Clinic 28



**nl**

De authentieke uitstraling van deze statige villa in Den Haag wordt in ere hersteld in het interieur door het gebruik van plinten, kaders en kroonlijsten. In deze cosmetische kliniek komt schoonheid in een warme, vertrouwelijke omgeving ultiem tot haar recht.

**fr**

Le rayonnement authentique de cette villa majestueuse située à La Haye reprend ses droits grâce à l'utilisation de plinthes, de cadres et de corniches. Dans cette clinique esthétique, la beauté est transcendée dans un environnement chaleureux et intime.

**en**

The authentic aura of the interior of this stately villa in The Hague has been restored by fitting skirting boards, framed panels and cornice mouldings. In this cosmetic clinic, beauty finds its full expression in a warm, familiar surroundings.

**de**

Die authentische Ausstrahlung dieser stattlichen Villa in Den Haag kommt durch den Einsatz von Sockelleisten, Rahmen und Eckleisten im Interieur gebührend zur Geltung. Diese Schönheitsklinik wird ihrem Konzept durch eine warme, vertrauliche Umgebung voll und ganz gerecht.

**es**

El uso de zócalos, paneles enmarcados y cornisas ha permitido recuperar el encanto genuino del interior de esta majestuosa casa señorial de La Haya. En esta clínica estética, la belleza encuentra su máxima expresión en un entorno cálido y acogedor.



**1** P8030 p. 102



**2** P8020 p. 103



**3** P8050 p. 105



**4** SX118 p. 116



# Clinic 28



1 R40 *p. 139*



2 P8030 *p. 102*



3 C217 *p. 85*





*"A perfect reflection of the true and natural beauty of mouldings"*

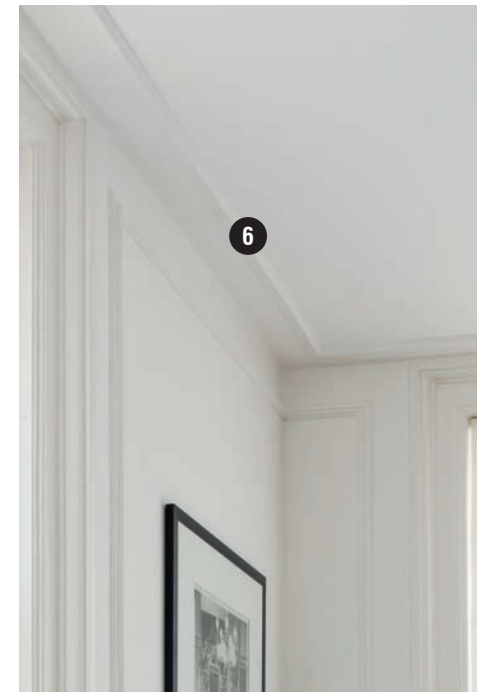

**4** P8050 p. 105



**5** SX118 p. 116



**6** PX103 p. 106





Sint-Petersburg  
— RU

# Metiendovivendum

1 SX118 p. 116



2 P8050 p. 105



3 D170 p. 132



4 P8030 | P8030F p. 102



5 P8020 | P8020F p. 103



6 P8050 | P8050F p. 105



7 SX118 | SX118F p. 116



8 C307 p. 90



*“Rooms that breathe history”*

— Sigisbert Engelbosch,  
Interior Designer





# *Manoir Fleuriri*

**Bordeaux**  
— FR







## nl

Barok is terug, maar dat dit niet per se hand in hand gaat met overdaad, laat dit interieur zien. De decoratieve profielen en hoekelementen geïnspireerd op het verleden, voegen een spel van lijnen en schaduw toe, zonder te prominent aanwezig te zijn.

## fr

Cet intérieur est la preuve que le retour du baroque n'est pas nécessairement synonyme d'excès. Les profils décoratifs et les éléments d'angle inspirés par le passé créent un jeu de lignes et d'ombres, sans se faire trop remarquer.

## en

Baroque is back, but that does not necessarily mean artistic excess – as this interior demonstrates. The decorative mouldings and corner features, inspired by the past, generate an array of lines and shadows without being obtrusive.

## de

Barock ist wieder da. Dass das aber nicht per se mit Überfluss zu tun hat, zeigt dieses Interieur. Die dekorativen, von der Vergangenheit inspirierten Profile und Eckelemente erzeugen ein Zusammenspiel von Linien und Schatten, ohne aufdringlich zu wirken.

## es

El barroco ha vuelto, aunque —tal y como demuestra este interior— no implica necesariamente un exceso artístico. Las molduras decorativas y los elementos de las esquinas, inspirados en el pasado, generan un juego de líneas y sombras casi imperceptible.

**1** C338A BA'ROCK p. 89



**4** P8040 p. 104



**7** P8050 p. 105



**2** C338B BA'ROCK p. 89



**5** P8020 p. 103



**8** SX118 p. 116



**3** P3020+P3020A p. 109

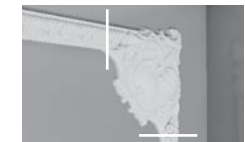

**6** D62 p. 136



1 DX162-2300 p. 106



2 C353 p. 82

Designed by  
Jacques Vergnaud



# Lan Lan

Madrid  
— ES



*“All it takes is one profile and a good deal of creativity to get to an extraordinary result”*



# ***BDBA***

*“Fashion and interior  
design: a perfect fit”*

❶ C901 p. 125



❷ P8030 p. 102



# Berto

Waregem  
— BE

*nl*

Het interieur in sterrenrestaurant Berto, weerspiegelt het karakter van de keuken: klassiek, met moderne toetsen. De perfect gestileerde basis in strak en clean wit, krijgt extra pit met strakke plinten en kroonlijsten en de indirecte verlichting zorgt voor de gepaste sfeer.

*fr*

L'intérieur du restaurant étoilé Berto reflète le caractère de sa cuisine : classique, agrémentée de touches modernes. La base élégante en blanc minimaliste est dynamisée par des plinthes et corniches épurées ; l'éclairage indirect crée quant à lui l'ambiance adéquate.

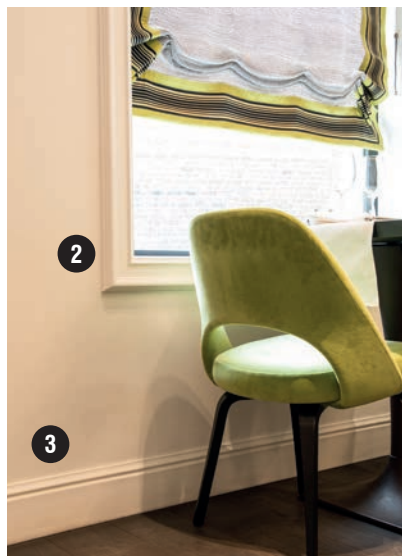
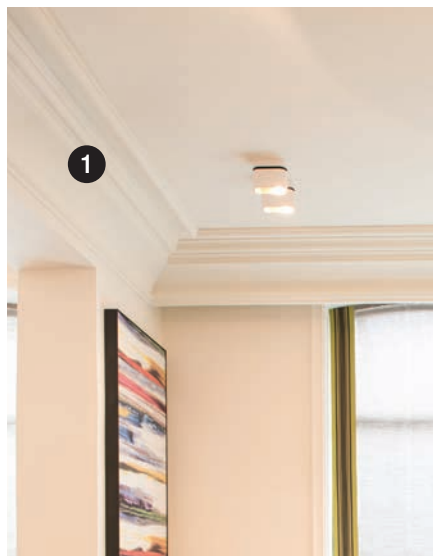



*“Orac Decor® profiles add extra flavor to clean and white spaces”*

### en

The interior of the renowned Berto restaurant reflects the character of the cuisine: classical with a modern touch. The perfectly styled base in taut, clean white is given extra emphasis by skirting-boards and cornice mouldings with simple, clean lines, while the indirect lighting creates a suitable ambience.

### de

Die Einrichtung im Sternerestaurant Berto spiegelt den Charakter der Küche wider: klassisch mit einem modernen Touch. Die perfekt stilisierte Basis aus elegantem, reinem Weiß wird durch die geradlinigen Sockel- und Eckleisten noch unterstrichen und die indirekte Beleuchtung sorgt für das passende Flair.

### es

El interior del renombrado restaurante Berto refleja la personalidad de su cocina: clásica con un toque de vanguardia. La sala, de estilo impoluto en color blanco puro e intenso, adquiere un protagonismo mayor gracias a los zócalos y las cornisas de líneas sencillas y depuradas. Por su parte, la iluminación indirecta ayuda a crear un ambiente óptimo.

**1** C336 p. 91



**2** DX121-2300 p. 104



**3** SX118 p. 116



**4** R09 p. 137



**5** C217 p. 85



**6** C901 p. 125



**7** R40 p. 139



# Eyes

## Night Only

Kortrijk  
— BE





*“Raw meets design: ORAC hotel make-over”*

**1** C374 ANTONIO p. 68

designed by Ulf Montiz



**2** C373 ANTONIO p. 68

designed by Ulf Montiz



**3** C991 CURTAIN PR. p. 70

designed by Ulf Montiz



**4** P3070 RADIUS p. 67

designed by Ulf Montiz



**5** C371 SHADE p. 66

designed by Ulf Montiz



**6** SX156 HIGH HEELS p. 116

designed by Xavier Denck







# Grayson Estate

The Hamptons  
— USA

1 SX118 p. 116



2 C334 p. 88



3 C333 p. 86



4 C331 p. 83





1 P9010 p. 104



2 P8020 p. 103



3 SX118 p. 116



4 C334 p. 88



5 C370 CLOUD p. 67

designed by Ulf Moritz



## nl

Van elegante klasse tot extravagantie: in dit unieke project worden alle registers opengetrokken. Elke ruimte vertelt een eigen verhaal. De indirecte verlichting zorgt voor een extra niveau van muur tot plafond en het Ulf Moritz profiel 'Cloud' creëert bijna letterlijk licht boven de zware gordijnen.

## fr

De l'élégance pure à l'extravagance : dans ce projet unique, tous les registres sont ouverts. Chaque pièce raconte sa propre histoire. L'éclairage indirect forme un niveau supplémentaire du mur au plafond et le profil « Cloud » d'Ulf Moritz crée presque littéralement de l'air au-dessus des lourds rideaux.

## en

From understated elegance to extravagance: all the stops are pulled out in this unique project. Every room tells its own story. The indirect lighting generates an extra level between the walls and the ceiling, and the Ulf Moritz "Cloud" moulding almost literally creates light above the dark curtains.

## de

Von Eleganz zu Extravanz: bei diesem einzigartigen Projekt werden alle Register gezogen. Jeder Raum erzählt seine eigene Geschichte. Die indirekte Beleuchtung sorgt für eine zusätzliche Abstufung von der Wand zur Decke und das Ulf-Moritz-Profil „Cloud“ erzeugt fast buchstäblich Luft über den schweren Vorhängen.

## es

Desde la elegancia sobria hasta la extravagancia, este proyecto único saca partido a todos los estilos. Cada estancia cuenta su propia historia. La iluminación indirecta da lugar a un nivel adicional entre las paredes y el techo, mientras que la moldura «Cloud» de Ulf Moritz crea, casi literalmente, luz por encima de las cortinas oscuras.

# Grayson Estate



2

1

2



**nl**

Diepte is het codewoord in deze rode tunnel. De convergerende, strakke lijnen - die ook de deur omarmen - en de indirecte verlichting aan het plafond toeverden deze donkere gang om in een lichtgevende tunnel. De diepte wordt benadrukt en leidt de aandacht naar de verte.

**fr**

La profondeur est le mot clé dans ce tunnel rouge. Les lignes convergentes épurées - qui encadrent également la porte - et l'éclairage indirect au plafond ont transformé ce couloir sombre en un tunnel lumineux. L'impression de profondeur est accentuée et attire l'attention vers l'horizon.

**en**

Depth is the keyword in this red tunnel. The straight converging lines, which also surround the door and the indirect lighting on the ceiling transform this dark passageway into a luminescent tunnel. Depth is emphasized and draws attention to the distant view.

**de**

Tiefe ist das Schlüsselwort bei diesem roten Tunnel. Die konvergierenden, geraden Linien - die auch die Tür umschlingen - und die indirekte Beleuchtung an der Decke verwandeln diesen dunklen Gang in einen leuchtenden Tunnel. Die Tiefe wird unterstrichen und führt den Blick in die Weite.

**es**

La profundidad es la palabra clave para este túnel rojo. Las líneas rectas convergentes, que también rodean la puerta, y la iluminación indirecta del techo transforman este oscuro pasillo en un túnel luminoso. La profundidad se acentúa y atrae la vista hacia el infinito.

**2** DX168-2300 p. 129

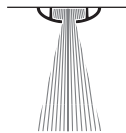

## Antonio Lighting Inspiration

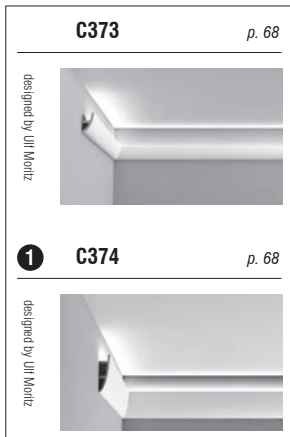

# The Red

Milano  
— IT

*“Using ORAC’s versatile products we’ve recreated a classic style”*

— *Beatriz Silvera,*  
*Spanish Interior designer*

# Casa **Madrid** — ES *Decor*





**nl**

Eén keer per jaar trekken alle professionals en liefhebbers van interieurdecoratie naar Casa Decor. Een oud pand wordt er opnieuw tot leven gewekt, met deze verrassende mix als resultaat. Het spel van kleur, licht en textuur op plafond, muren en zelfs meubels krijgt iets bijzonders met de Orac Decor® profielen en elementen.

**fr**

Une fois par an, tous les professionnels et amateurs de décoration d'intérieur viennent découvrir Casa Decor. Un ancien bâtiment y reprend vie, créant ainsi ce mariage surprenant. Le jeu de couleur, de lumière et de texture sur le plafond, les murs et même les meubles est particulièrement mis en valeur grâce aux profils et aux éléments Orac Decor®.

**en**

Once a year all interior design professionals and enthusiasts make a pilgrimage to Casa Decor. New life is breathed into an old building, with this surprising mix as a result. The Orac Decor® mouldings and elements give a special touch to the play of colour, light and texture on the ceiling, walls, and even the furniture.



**1** C336 p. 91



**2** C201 p. 85



**3** P8030 p. 102



**4** SX118 p. 116



**5** DX157-2300 p. 107



**6** P8020 p. 103



**7** F30 p. 140





**de**

Einmal jährlich zieht es alle, die beruflich oder aus privater Liebhaberei mit Inneneinrichtung zu tun haben, zur Messe Casa Decor. Ein altes Gebäude wird wieder zum Leben erweckt, und dieser überraschende Mix ist das Resultat. Das Zusammenspiel von Farbe, Licht und Textur an Decke, Wänden und sogar Möbeln erhält dank der Orac-Decor-Profile und -Elemente das besondere Etwas.

**es**

Una vez al año, todos los profesionales y los amantes del diseño de interiores acuden en peregrinación a Casa Decor, en España. Un edificio antiguo y un nuevo interiorismo son la combinación perfecta para un resultado sorprendente. Las molduras y los elementos de Orac Decor satisfacen la exigencia de los decoradores y arquitectos de interior de más prestigio, aportando un toque especial al juego de colores, luces y texturas de los techos, las paredes e, incluso, los muebles.





1 C340 p. 91



2 D400 p. 132



3 K200+D320 p. 146

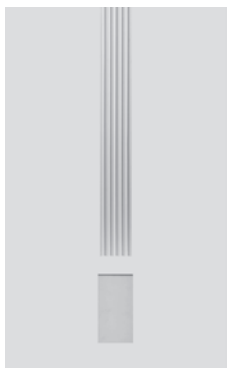

4 P8020 p. 83



5 SX138 p. 116



6 PX103 p. 106



7 PX102 p. 107



8 C217 p. 85



9 SX137 p. 115



# Casa Decor



1 C372 FLUXUS p. 66

designed by Ulf Moritz



2 P3071 GOLF p. 67

designed by Ulf Moritz



# Rabo | Amsterdam — NL Bank

*“The DNA of Orac Decor<sup>®</sup> profiles allowed us to create a homely feeling in a business environment”*

— MEMO, Interior Composers

*“A living Pinterest, there’s no better way to subscribe this showroom”*

**R** CEILING ROSES p. 136



**1** C371 SHADE p. 66



designed by Jiri Moritz



# Pand

# 16

Sint-Niklaas  
— BE



*"Traditional luxury in a  
historic setting"*

# 't Goude Hoofst

Den Haag  
— NL





**1** P9010 *p. 104*



**2** P8030 *p. 102*



**3** SX118 *p. 116*



**4** C371 SHADE *p. 66*



**5** G72 SMILE *p. 72*



**6** G73 | G74 CURL *p. 72*



**nl**

Dankzij de rijkelijke mix van Orac Decor® profielen en frivole Ulf Moritz elementen, worden de hotelgasten, in de oudste herberg van Den Haag, in luxe, weelde en schoonheid ontvangen.

**fr**

Grâce à la combinaison abondante de profils Orac Decor® et d'éléments Ulf Moritz extravagants, les hôtes de la plus ancienne auberge de La Haye sont accueillis dans la beauté, le luxe et la volupté.

**en**

Thanks to the rich mix of Orac Decor® mouldings and playful Ulf Moritz elements, hotel guests at the oldest inn of The Hague are welcomed in luxury, opulence and beauty.

**de**

Dank dem vielseitigen Mix aus Orac Decor®-Profilen und üppigen Ulf-Moritz-Elementen werden die Hotelgäste in der ältesten Herberge Den Haags in einem Ambiente von Luxus, Pracht und Schönheit willkommen geheißen.

**es**

Gracias a la sofisticada combinación de las molduras de Orac Decor® con los divertidos elementos de Ulf Moritz, los huéspedes del hotel más antiguo de La Haya encuentran aquí un oasis de lujo, opulencia y belleza.

1 P3070 RADIUS p. 67

designed by Ulf Moritz

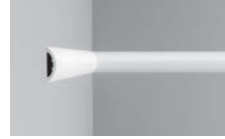

2 C370 CLOUD p. 67

designed by Ulf Moritz



3 P3071 GOLF p. 67

designed by Ulf Moritz



*"A cosmopolitan atmosphere thanks to the organic shapes created by Ulf Moritz' profiles"*

**Roeselare**  
— BE

***Bardò***

# *Pink Eye* **Antwerpen** — BE

ORAC  
DECOR

3 SX155 p. 155



4 F12 p. 140

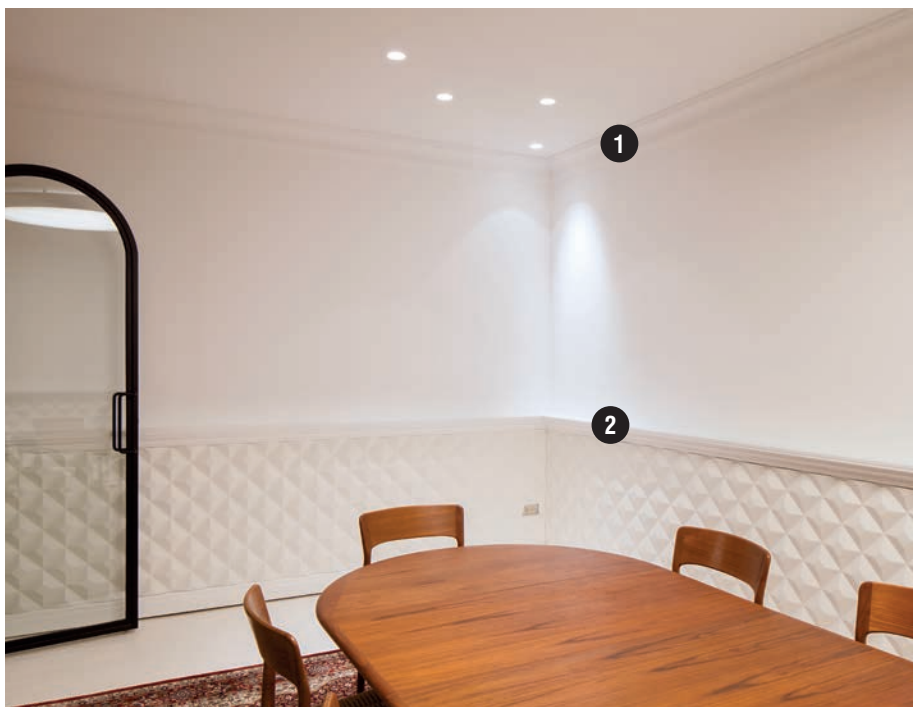

1 C217 p. 88



2 DX170-2300 p. 105



1 C371 SHADE p. 66

designed by Ulf Meritz



2 DX163-2300 p. 115



3 C370 CLOUD

designed by Ulf Meritz



5 P3071 GOLF p. 67

designed by Ulf Meritz



4 SX167 DUNE p. 67

designed by Ulf Meritz



6 R66 p. 138



# Big One

Oostende  
— BE



P PANEL MOULDINGS 100-111



*nl*

Als je de interieurwereld wil inspireren om creatief te zijn, moet je zelf het goede voorbeeld geven. In de showroom op het ORAC hoofdkantoor is de hoofdrol op verrassende wijze ingenomen door de uitgebreide collectie.

*fr*

Pour être une source d'inspiration créative dans l'univers de la décoration d'intérieur, il faut soi-même donner le bon exemple. Dans le show-room du siège d'ORAC, la collection étendue de la marque occupe une place prépondérante, et ce, d'une manière particulièrement étonnante.

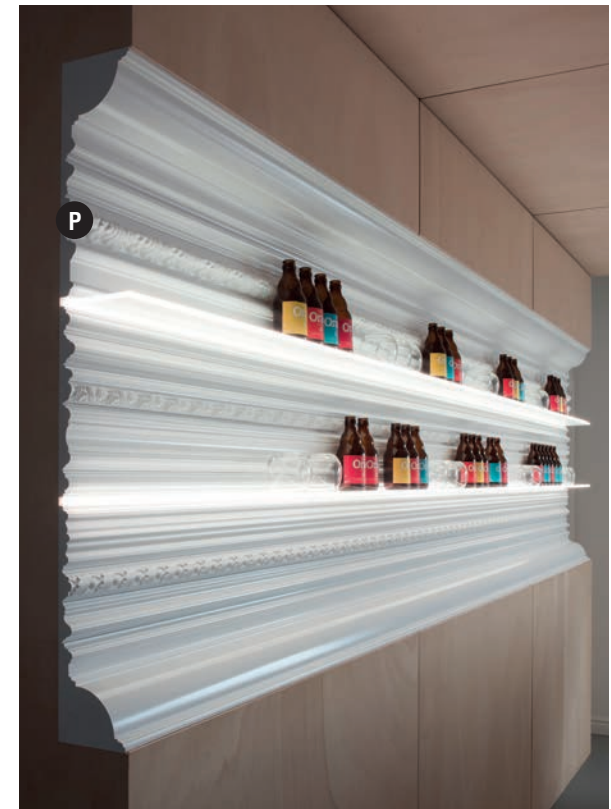



**en**

If you want to inspire creativity in the interior design world, you have to set a good example. In the showroom at the ORAC head office, the extensive collection takes centre stage in a really surprising way.

**de**

Wenn man die Welt der kreativen Inneneinrichtung inspirieren will, muss man selbst als gutes Beispiel vorangehen. Im Showroom der ORAC-Hauptniederlassung sorgt die reichhaltige Kollektion für kreative Überraschungen.

**es**

Para servir de inspiración creativa dentro del mundo del diseño de interiores, es preciso dar un buen ejemplo. En la sala de exposiciones de la sede central de ORAC en Ostende (Bélgica), una amplia colección acapara el protagonismo de una forma realmente sorprendente.



*“Show 'm what you've got: the live interpretation of the ORAC identity”*



*nl*

In het gastenhuis Porters gaat het warme en tijdloze interieur in perfecte harmonie met de architectuur van het gebouw. Op een bijna theatrale manier eisen zuilen, kroonlijsten en wandbekleding hun aandacht in elk van de kamers op.

*fr*

Dans la maison d'hôtes Porters, l'intérieur chaleureux et intemporel est en parfaite harmonie avec l'architecture du bâtiment. D'une manière théâtrale, les colonnes, corniches et revêtements muraux attirent tous les regards dans chacune des chambres.

# House of Antwerp — BE Porters

1 K1002+K1152 p. 144



2 C422 p. 89



3 R76 p. 138



2



# Pieter Porters



## en

In Porters Guesthouse, the traditional warm interior harmonises perfectly with the architecture of the building. In every room columns, cornice mouldings and wall coverings draw your attention in an almost theatrical manner.

## de

Im Gästehaus Porters steht das warme, zeitlose Interieur in perfektem Einklang mit der Gebäudearchitektur. Auf fast theatralische Weise fordern die Säulen, Eckleisten und Wandverkleidungen in jedem einzelnen Zimmer die ihnen gebührende Aufmerksamkeit ein.

## es

En Porters Guesthouse, la calidez tradicional del interior se conjuga a la perfección con la arquitectura del edificio. En cada una de las estancias, las columnas, las cornisas y los recubrimientos de las paredes acaparan todas las miradas de una forma casi teatral.



**1** C900 *p. 89*



**2** C307 *p. 90*



**3** C338B BA'ROCK *p. 89*



**4** SX118 *p. 116*



**5** P4020 *p. 102*



**6** DX121-2300 *p. 104*



**7** P7030 *p. 104*



**8** P9010 *p. 104*



**9** PX103+PX103A *p. 110*



**10** P3020A+P3020 *p. 109*



**11** K200 *p. 146*



**12** D320 *p. 146*



**13** D401+D402 *p. 132*



**14** D503+D504+D507 *p. 130*



**15** M9010L *p. 134*



**16** P20 *p. 147*



*Reflecting*  
your  
*Imagination*

ORAC<sup>®</sup>  
DECOR





*Liberté*

Let your Creativity flow



# Product Overview

	<b>CORNICE MOULDINGS</b>	<b>PANEL MOULDINGS</b>	<b>SKIRTING BOARDS</b>	<b>INDIRECT LIGHTING</b>	<b>DECO ELEMENTS</b>
	KROONLIJSTEN CORNICHES ECKLEISTEN CORNISAS	WANDLIJSTEN CIMAISES WAND- UND FRIESLEISTEN MOLDURAS	PLINTEN PLINTHES SOCKELLEISTEN ZÓCALOS	INDIRECTE VERLICHTING ÉCLAIRAGE INDIRECT INDIREKTE BELEUCHTUNG ILUMINACIÓN INDIRECTA	DECORATIEVE ELEMENTEN ÉLÉMENTS DÉCORATIFS ZIERELEMENTE ELEMENTOS DE DECORACIÓN
<b>ULF MORITZ</b>	<b>p.67-70</b>	<b>p.67</b>	<b>p.67</b>	<b>p.66-69</b>	<b>p.71-79</b>
3D DARING DESIGNS	PUROTOUCH <sup>®</sup>	PUROTOUCH <sup>®</sup>	PUROTOUCH <sup>®</sup> DUROPOLYMER <sup>®</sup>	PUROTOUCH <sup>®</sup>	PUROTOUCH <sup>®</sup> DUROPOLYMER <sup>®</sup>
<b>LUXXUS</b>	<b>p.82-91</b>	<b>p.102-105</b>	<b>p.114-117</b>	<b>p.120-125</b>	<b>p.128-148</b>
EXCLUSIVE & STYLISH CONCEPTS	PUROTOUCH <sup>®</sup>	PUROTOUCH <sup>®</sup> DUROPOLYMER <sup>®</sup>	DUROPOLYMER <sup>®</sup>	PUROTOUCH <sup>®</sup>	PUROTOUCH <sup>®</sup> DUROPOLYMER <sup>®</sup>
<b>AXXENT</b>	<b>p.92-96</b>	<b>p.106-108</b>	<b>p.114-117</b>		
HIGH QUALITY INTERIOR SOLUTIONS	DUROPOLYMER <sup>®</sup>	DUROPOLYMER <sup>®</sup>	DUROPOLYMER <sup>®</sup>		
<b>BASIXX</b>	<b>p.97</b>				
BUDGET FRIENDLY DESIGNS	DUROFOAM <sup>®</sup>				



## **Purotouch<sup>®</sup>**

Een kwalitatieve polyurethaan van hoge densiteit.

Un polyuréthane moulé de haute densité.

A moulded quality high-density polyurethane.

Ein hochwertiger, hochdichter Polyurethanschaum.

Poliuretano de alta calidad y de elevada densidad.

## **Duropolym<sup>®</sup>**

Geëxtrudeerde en impactbestendige polystyreenmix van hoge densiteit.

Un polymère extrudé résistant aux impacts à base d'un mélange de polystyrènes haute densité.

An extruded and impact-resistant polymer based on a high-density polystyrene.

Extrudierter und schlagfester, hochdichter Polystyrol-Mix.

Polímero fabricado por extrusión, resistente a impactos fuertes a base de una mezcla de poliestireno de alta densidad.

## **Durofoam<sup>®</sup>**

Geëxtrudeerde lichtgewicht polystyreenmix van medium densiteit.

Un polymère léger extrudé à base d'un mélange de polystyrènes de densité moyenne.

An extruded lightweight polymer based on a medium-density polystyrene blend.

Extrudiertes, leichtes Polymer auf der Grundlage eines Polystyrol-Mix mittlerer Dichte.

Polímero extrusionado de peso ligero a base de una mezcla de poliestireno de densidad media.

## **ADHESIVES AND ACCESSORIES**

LIJMEN EN TOEBEHOREN  
COLLES ET ACCESSOIRES  
KLEBER UND ZUBEHÖR  
ADHESIVO Y ACCESORIOS

**p.148-153**





## nl

Ulf Moritz brengt beweging en dynamiek in je interieur. De collectie designelementen, op wand of plafond, al dan niet met licht geïntegreerd, zorgt voor een ongeëvenaard 3D-effect. Krachtig, imposant en elegant tegelijk.

## en

Ulf Moritz brings movement and dynamics to your interior. The collection of design elements for walls and ceilings, with or without integrated lighting, creates an unparalleled 3D effect. Powerful, imposing and elegant at the same time.

## es

Ulf Moritz aporta movimiento y dinamismo a su interior. Esta colección de elementos de diseño crea un efecto 3D único en paredes y techos y pueden colocarse con o sin iluminación integrada. Intenso, imponente y elegante al mismo tiempo.

## fr

Ulf Moritz : un nom de caractère pour votre intérieur. Au mur ou au plafond, avec un éclairage intégré ou non, les éléments design de la collection assurent un vécu 3D incomparable. Une combinaison de puissance, de grandeur et d'élégance.

## de

Ulf Moritz bringt Dynamik und Bewegung in Ihre Räume. Die Kollektion aus Designelementen für Wände oder Decke, mit oder ohne integrierte Beleuchtung, sorgt für einen unübertroffenen 3D-Effekt. Kraftvoll, imposant und elegant zugleich.

# Ulf Moritz Collection

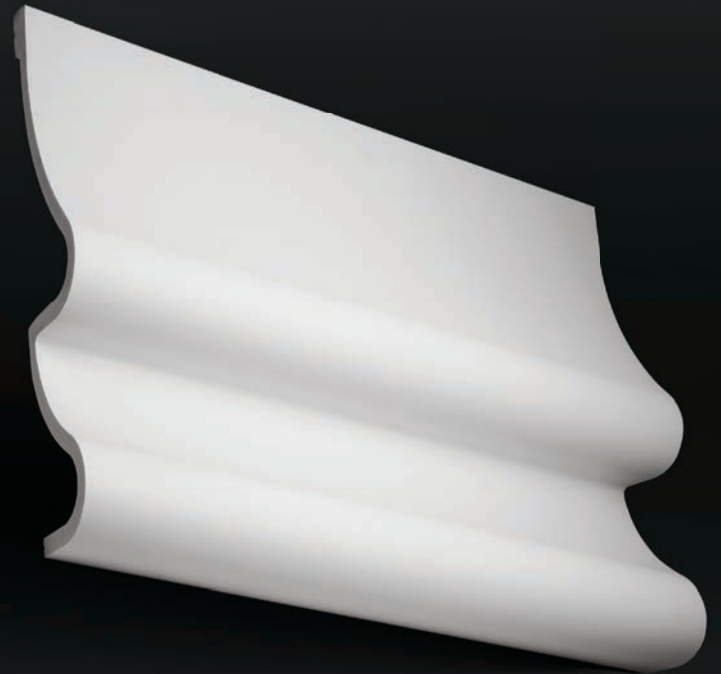

## Ulf Moritz Collection



❶ **C374 ANTONIO** p. 68

❷ **C371 SHADE** p. 66



### C371 SHADE

200 x 18,5 x 5,8 cm  
Purotouch<sup>®</sup>

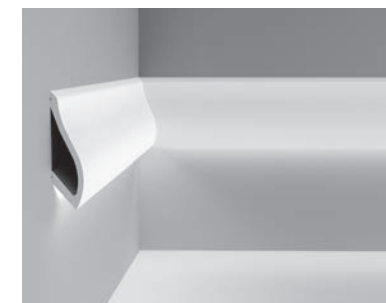

ULF MORITZ

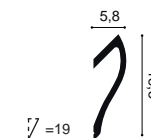

### C372 FLUXUS

200 x 28 x 7 cm  
Purotouch<sup>®</sup>



ULF MORITZ

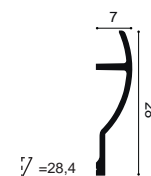

# Ulf Moritz Collection



**C370 CLOUD**

ULF MORITZ

200 x 20 x 16 cm  
Purotouch<sup>®</sup>

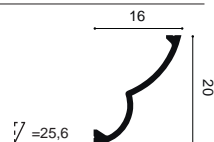

**P3071 GOLF**

200 x 37,2 x 7,6 cm  
Purotouch<sup>®</sup>

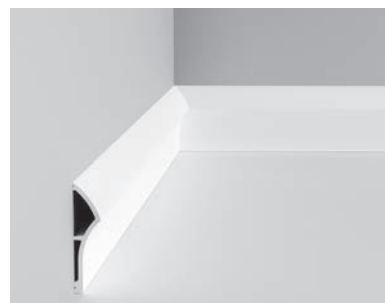

**SX167 DUNE**

ULF MORITZ

200 x 17,3 x 4,3 cm  
Duropolymer<sup>®</sup>

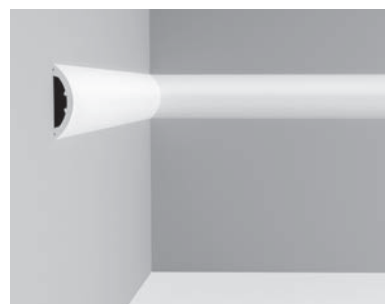

**P3070 RADIUS**

ULF MORITZ

200 x 12,5 x 3,2 cm  
Purotouch<sup>®</sup>

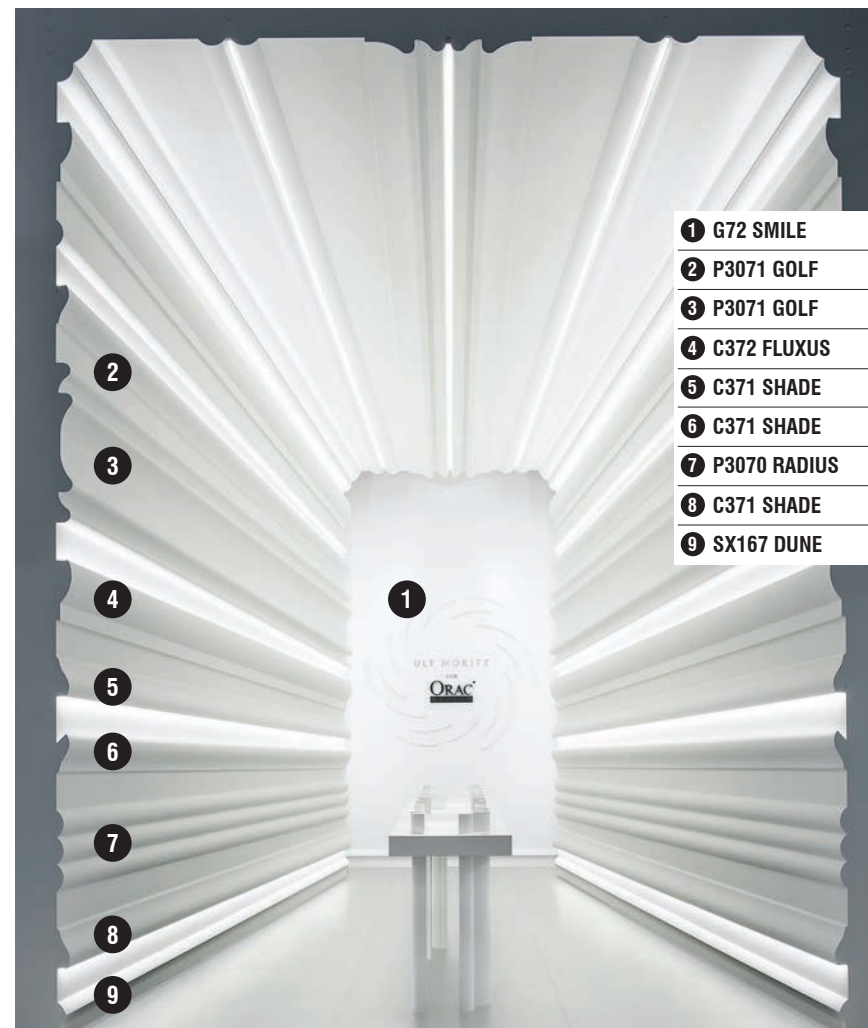

- |   |              |       |
|---|--------------|-------|
| 1 | G72 SMILE    | p. 72 |
| 2 | P3071 GOLF   | p. 67 |
| 3 | P3071 GOLF   | p. 67 |
| 4 | C372 FLUXUS  | p. 66 |
| 5 | C371 SHADE   | p. 66 |
| 6 | C371 SHADE   | p. 66 |
| 7 | P3070 RADIUS | p. 67 |
| 8 | C371 SHADE   | p. 66 |
| 9 | SX167 DUNE   | p. 67 |

## Ulf Moritz Collection

1 C374 ANTONIO p. 68

2 C991 p. 70



**C373 | C373F ANTONIO**

200 x 8 x 5 cm  
Purotouch<sup>®</sup>

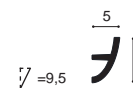

ULF MORITZ



**C374 | C374F ANTONIO**

200 x 18 x 5 cm  
Purotouch<sup>®</sup>

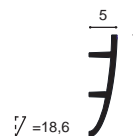

ULF MORITZ

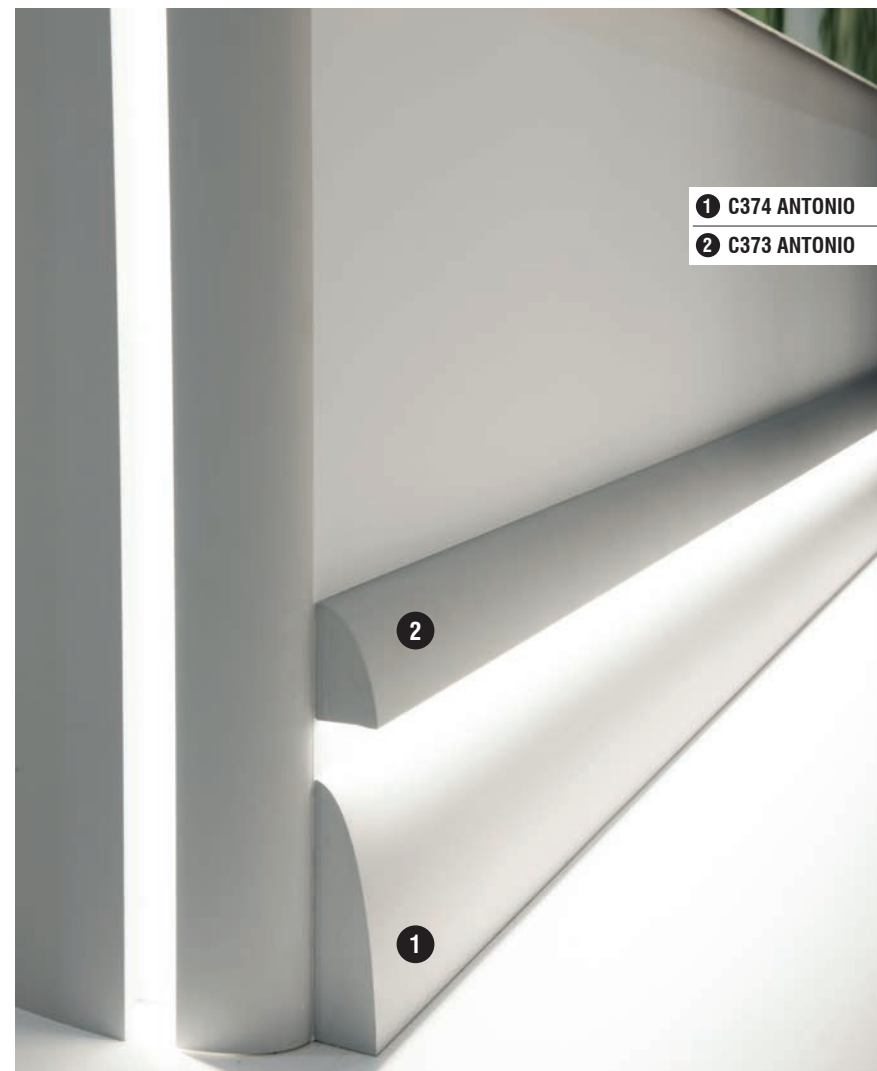

- 1 C374 ANTONIO *p. 68*
- 2 C373 ANTONIO *p. 68*



**C991 CURTAIN PROFILE**

ULF MORITZ

200 x 11 x 14 cm  
Purotouch<sup>®</sup>

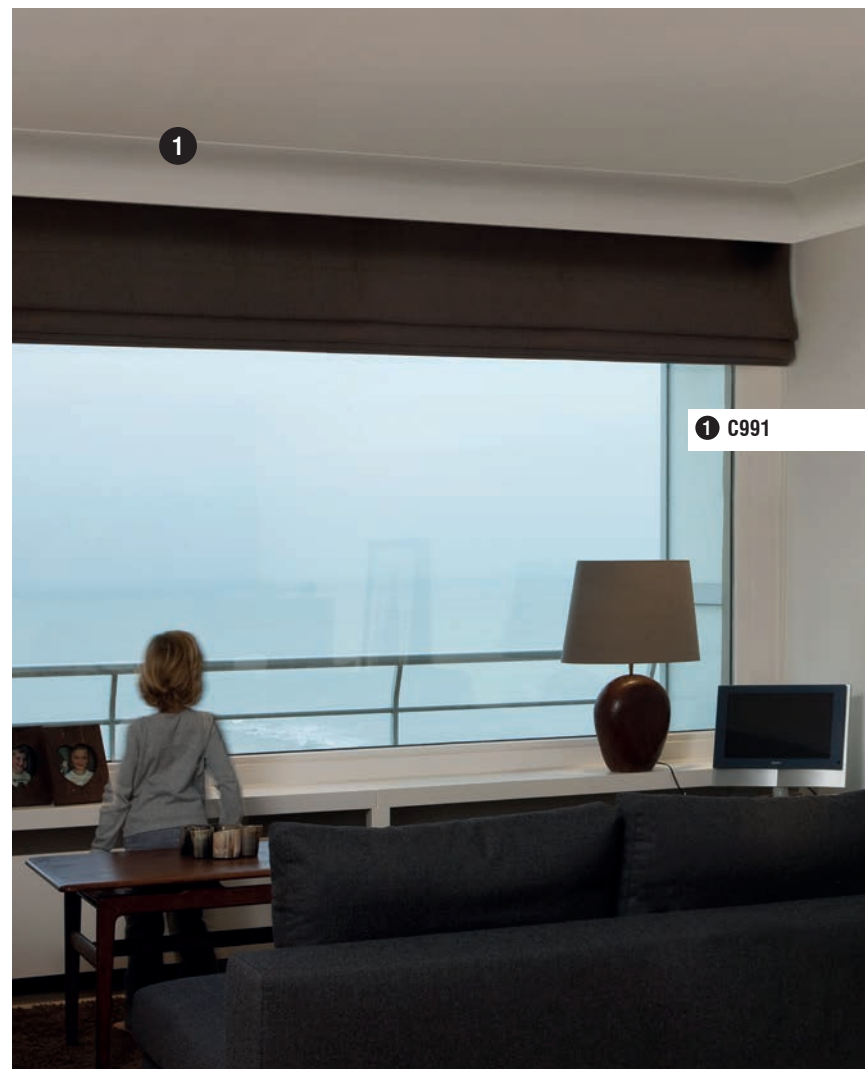
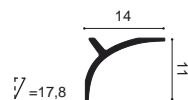

p. 70



# Ulf Moritz Collection



**G71 SCALA**

ULF MORITZ

42,2 x 35 x 1,5 cm  
Purotouch®

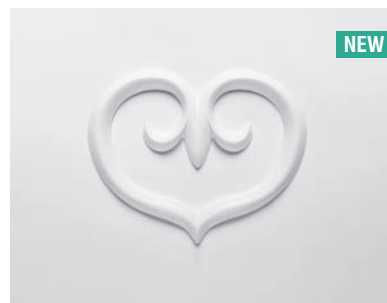
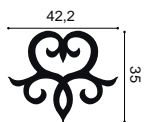

NEW

**G75 SCALA**

ULF MORITZ

27 x 21 x 1,4 cm  
Purotouch®



NEW

**G76 SCALA**

ULF MORITZ

8 x 17,8 x 1,5 cm  
Purotouch®

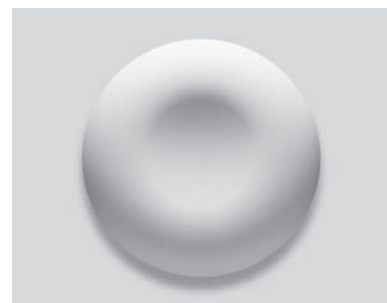

**R70 FOCUS**

ULF MORITZ

Ø 60 x 7,7 cm  
Purotouch®

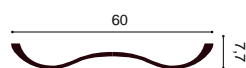

- 1 C371 SHADE p. 66
- 2 G71 SCALA p. 71
- 3 SX167 DUNE p. 67

# Ulf Moritz Collection



**G70 FOLIO**

ULF MORITZ

20 x 9 x 2,7 cm  
Duropolymer<sup>®</sup>



**G72 SMILE**

ULF MORITZ

42,5 x 6,8 x 1 cm  
Duropolymer<sup>®</sup>

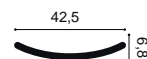

**G78 LILY**

ULF MORITZ

8,8 x 4,4 x 1,9 cm  
Duropolymer<sup>®</sup>



**G77 LILY**

ULF MORITZ

19,4 x 8,8 x 1,8 cm  
Duropolymer<sup>®</sup>



**G73L CURL MINI**

ULF MORITZ

20,1 x 18,1 x 1 cm  
Purotouch<sup>®</sup>

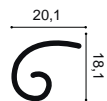

**G73R CURL MINI**

ULF MORITZ

20,1 x 18,1 x 1 cm  
Purotouch<sup>®</sup>

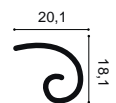

**G74L CURL MAXI**

ULF MORITZ

25,4 x 24,4 x 1,1 cm  
Purotouch<sup>®</sup>

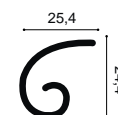

**G74R CURL MAXI**

ULF MORITZ

25,4 x 24,4 x 1,1 cm  
Purotouch<sup>®</sup>

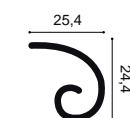



- |           |                      |              |
|-----------|----------------------|--------------|
| <b>1</b>  | <b>G77 LILY</b>      | <i>p. 72</i> |
| <b>2</b>  | <b>P3071 GOLF</b>    | <i>p. 67</i> |
| <b>3</b>  | <b>C372 FLUXUS</b>   | <i>p. 66</i> |
| <b>4</b>  | <b>C373 ANTONIO</b>  | <i>p. 68</i> |
| <b>5</b>  | <b>C374 ANTONIO</b>  | <i>p. 68</i> |
| <b>6</b>  | <b>G74 CURL MAXI</b> | <i>p. 72</i> |
| <b>7</b>  | <b>G72 SMILE</b>     | <i>p. 72</i> |
| <b>8</b>  | <b>G73 CURL MINI</b> | <i>p. 72</i> |
| <b>9</b>  | <b>SX167 DUNE</b>    | <i>p. 67</i> |
| <b>10</b> | <b>C371 SHADE</b>    | <i>p. 66</i> |

Ulf Moritz Collection

WAND / MUR / WALL / WAND / PARED

---



Ulf Moritz Collection

WAND / MUR / WALL / WAND / PARED

---

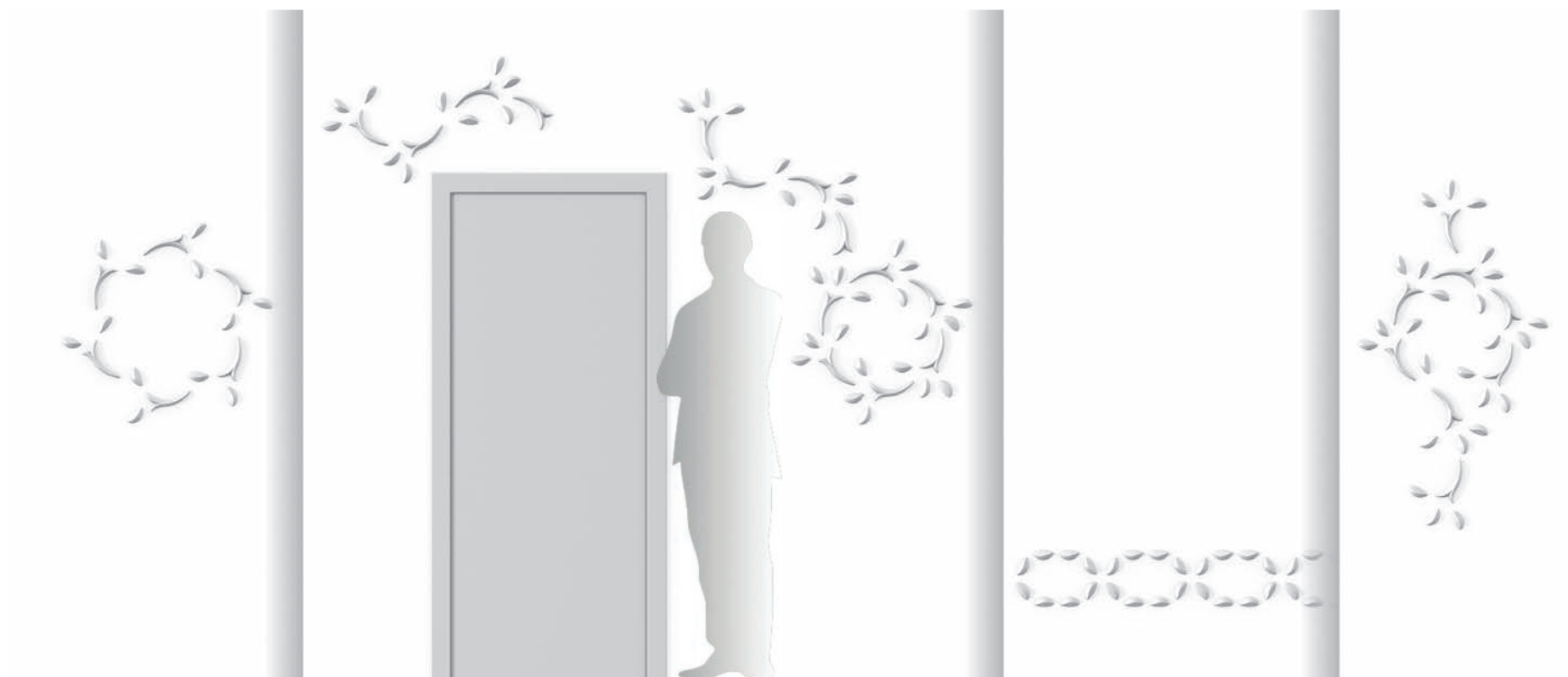

Ulf Moritz Collection

WAND / MUR / WALL / WAND / PARED

---

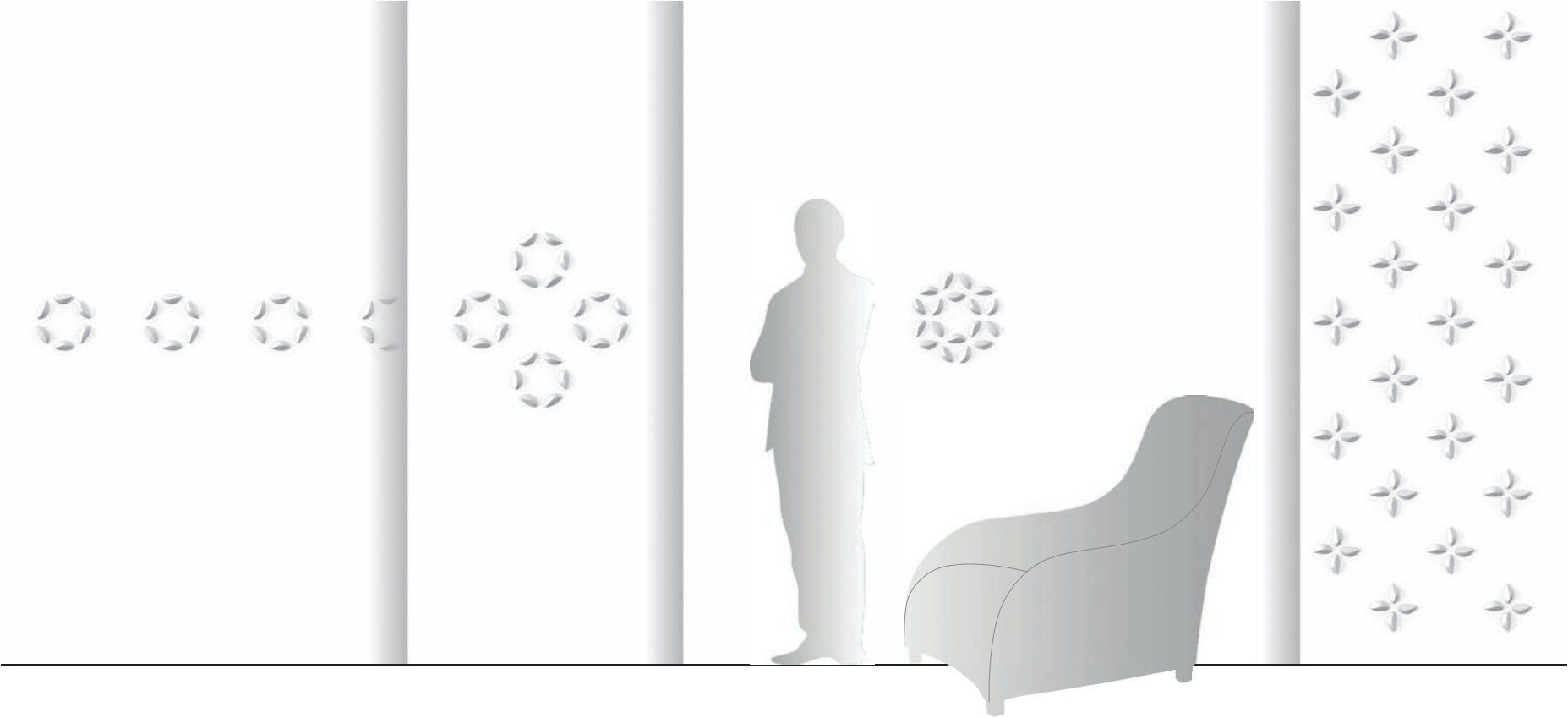

Ulf Moritz Collection

WAND / MUR / WALL / WAND / PARED

---

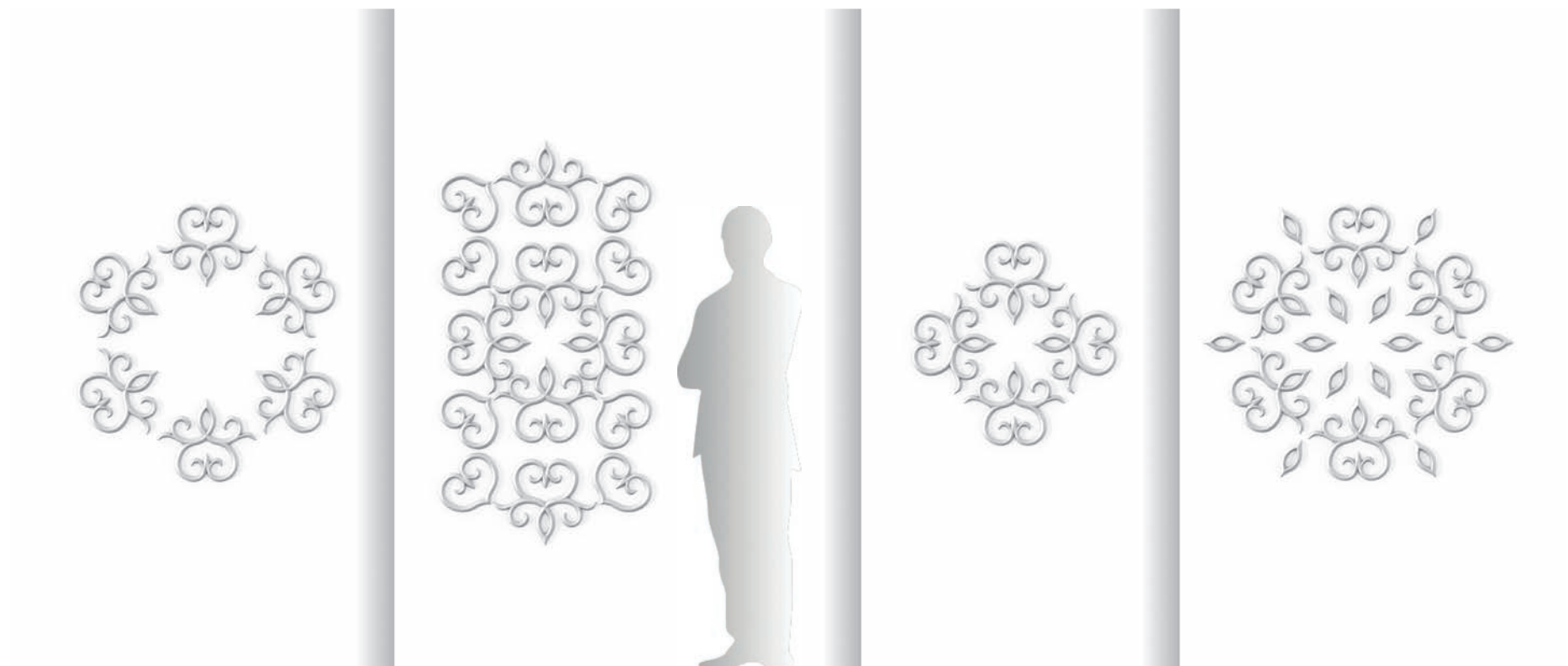

Ulf Moritz Collection

PLAFOND / CEILING / DECKE / TECHO

---

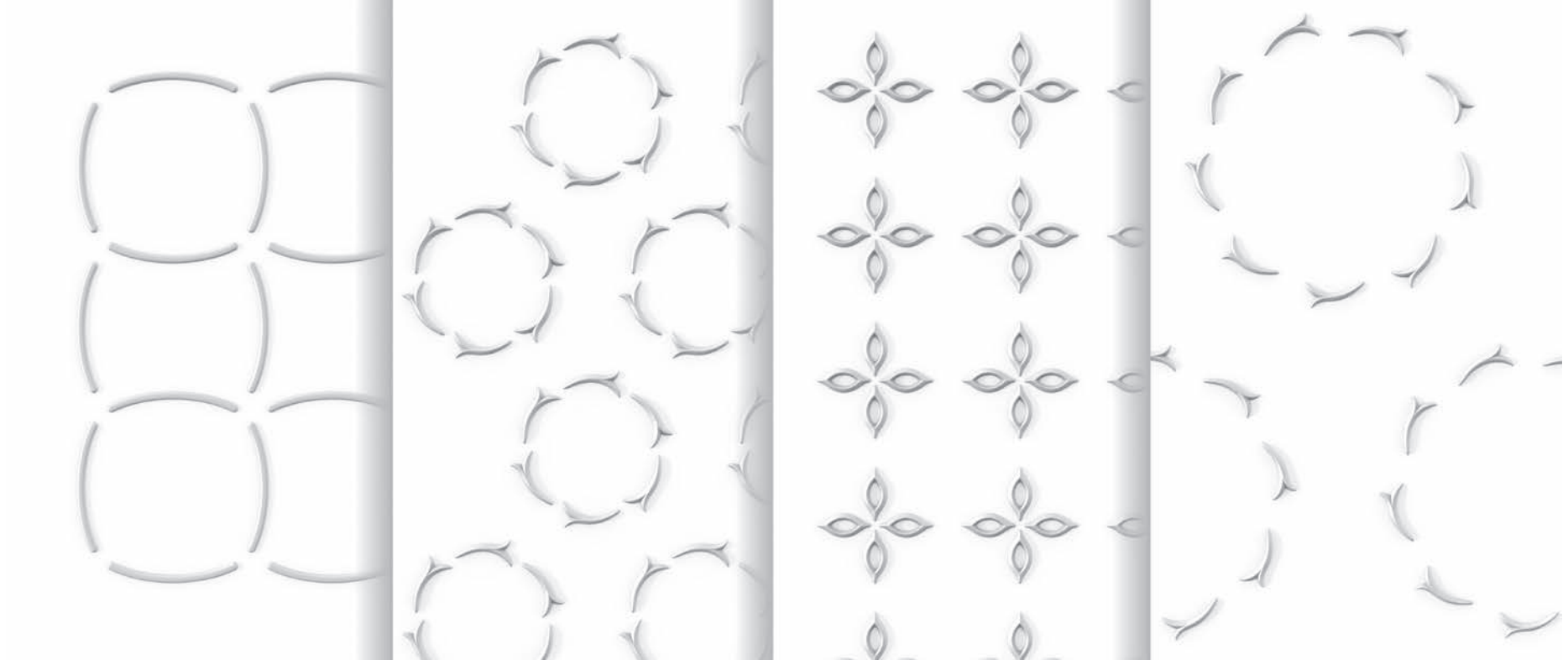



Ulf Moritz Collection

PLAFOND / CEILING / DECKE / TECHO

---

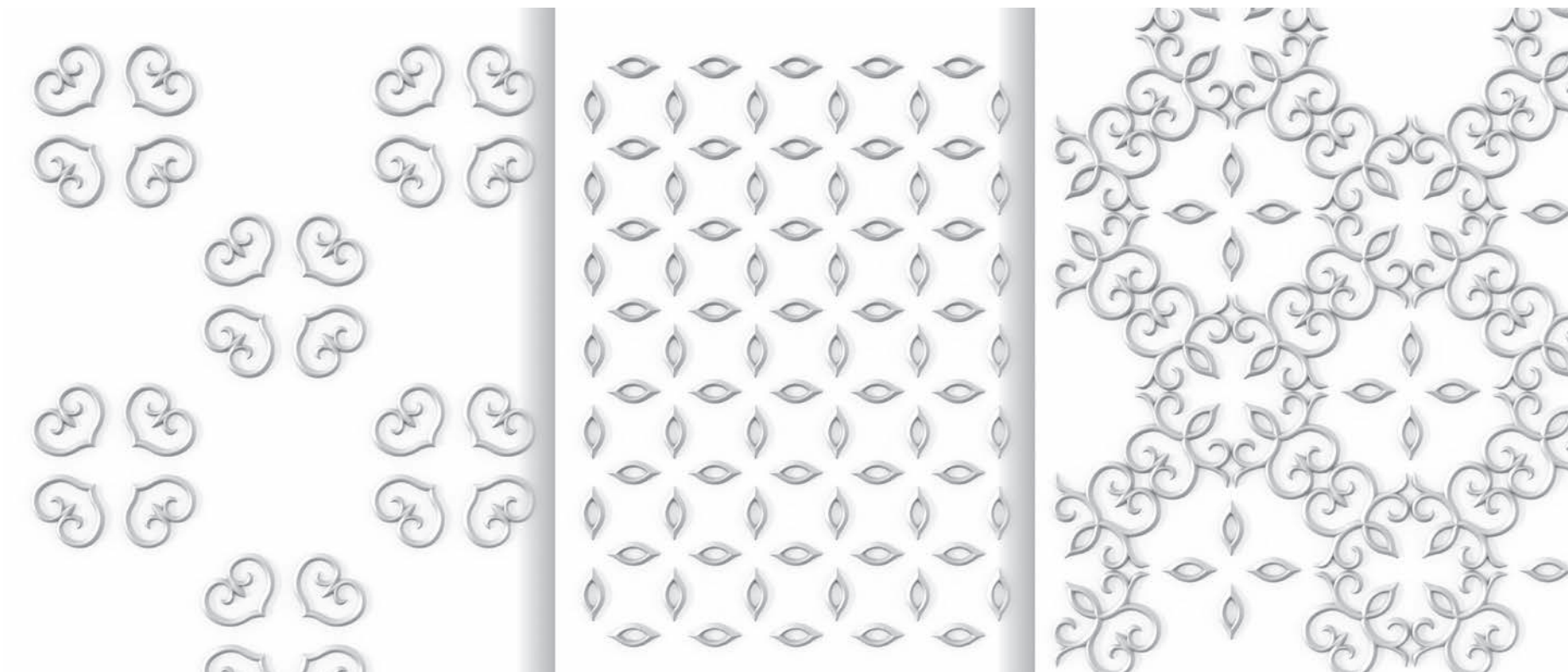



## nl

De overgang tussen muur en plafond wordt met een kroonlijst pas echt boeiend. Van strak tot barok, van decoratief tot functioneel; voor elk budget bieden we een kwaliteitsoplossing. De profielen zijn eenvoudig te plaatsen en een groot aantal referenties zijn ook in flexibele uitvoering beschikbaar.

## fr

Une moulure ajoute un effet visuellement intéressant à la transition entre mur et plafond. Quel que soit votre budget, nous vous proposons une solution de qualité : du style minimaliste au baroque, de l'élément décoratif au fonctionnel. Les profils sont faciles à poser, et un grand nombre de produits sont également disponibles en version flexible.

## en

A cornice creates a visually attractive transition from wall to ceiling. From sleek to baroque, from decorative to functional – we offer a quality solution for every budget. The profiles are easy to install, and a large number of designs are available in flexible versions.

## de

Der Übergang zwischen Wand und Decke wird mit einer Leiste zu einem eindrucksvollen Blickfang. Von geradlinig bis barock, von dekorativ bis funktional; wir haben für jedes Budget eine Qualitätslösung im Angebot. Die Leisten sind einfach anzubringen und sind vielfach in flexiblen Ausführungen erhältlich.

## es

Una cornisa crea una transición de la pared al techo visualmente atractiva. De lo sencillo a lo barroco, de lo decorativo a lo funcional; ofrecemos una solución de calidad para todos los bolsillos. La instalación de los perfiles es muy fácil y, además, hay disponible un amplio abanico de diseños en versiones flexibles.

Kroonlijsten  
Corniches  
Cornice Mouldings  
Eckleisten  
Cornisas





**C250 | C250F** LUXXUS

200 x 1,6 x 1,6 cm  
Purotouch<sup>®</sup>  $\nabla = 2,2$  



**C360** LUXXUS

200 x 2,1 x 6 cm  
Purotouch<sup>®</sup>  
Designed by Jacques Vergracht  $\nabla = 6,0$  



**C230 | C230F** LUXXUS

200 x 2,9 x 2,9 cm  
Purotouch<sup>®</sup>  $\nabla = 4,0$  

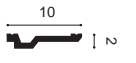

**C356** LUXXUS

200 x 2 x 10 cm  
Purotouch<sup>®</sup>  
Designed by Jacques Vergracht  $\nabla = 10,0$  



**C353** LUXXUS

200 x 3 x 16,5 cm  
Purotouch<sup>®</sup>  
Designed by Jacques Vergracht  $\nabla = 16,5$  



**C355** LUXXUS

200 x 3,5 x 11,1 cm  
Purotouch<sup>®</sup>  
Designed by Jacques Vergracht  $\nabla = 11,1$  



**C354** LUXXUS

200 x 4 x 21,5 cm  
Purotouch<sup>®</sup>  
Designed by Jacques Vergracht  $\nabla = 21,5$  

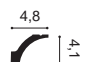

**C260 | C260F** LUXXUS

200 x 4,1 x 4,8 cm  
Purotouch<sup>®</sup>  $\nabla = 6,0$  



**C305** LUXXUS

200 x 4,7 x 15,5 cm  
Purotouch<sup>®</sup>

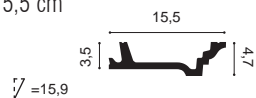

**C305 + C213** LUXXUS

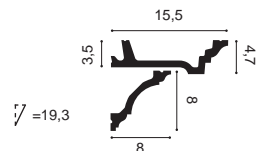

**C305 + C211** LUXXUS

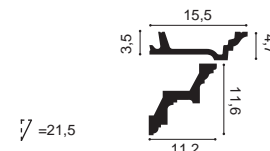

**C215 | C215F** LUXXUS

200 x 4,7 x 4,7 cm  
Purotouch<sup>®</sup>

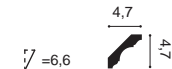

**C322 | C322F** LUXXUS

200 x 5 x 4,2 cm  
Purotouch<sup>®</sup>

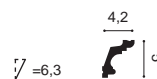

**C602 | C602F** LUXXUS

200 x 5,3 x 5 cm  
Purotouch<sup>®</sup>

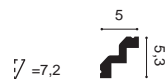

**C400** LUXXUS

200 x 6 x 10 cm  
Purotouch<sup>®</sup>

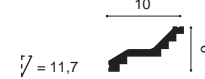

**C331 | C331F** LUXXUS

200 x 6,4 x 13,5 cm  
Purotouch<sup>®</sup>

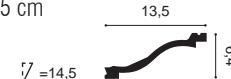



**C200 | C200F** LUXXUS

200 x 6,5 x 5,7 cm  
Purotouch<sup>®</sup>

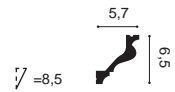

**C214 | C214F** LUXXUS

200 x 6,6 x 3,1 cm  
Purotouch<sup>®</sup>

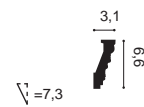

**C212 | C212F** LUXXUS

200 x 7,3 x 4,5 cm  
Purotouch<sup>®</sup>

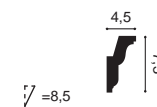

**C220 | C220F** LUXXUS

200 x 7,6 x 11,6 cm  
Purotouch<sup>®</sup>

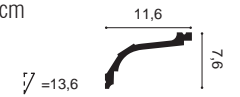

**C213 | C213F** LUXXUS

200 x 8 x 8 cm  
Purotouch<sup>®</sup>

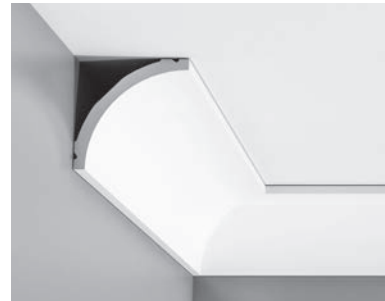
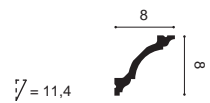

**C240 | C240F** LUXXUS

200 x 8 x 8 cm  
Purotouch<sup>®</sup>

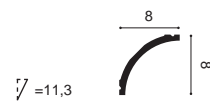

**C341 | C341F HERITAGE M** LUXXUS

200 x 8,8 x 12,2 cm  
Purotouch<sup>®</sup>





**C321 | C321F**

LUXXUS

200 x 9,9 x 5 cm  
Purotouch<sup>®</sup>

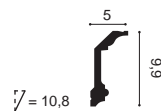

**C902 | C902F**

LUXXUS

200 x 10,3 x 10,3 cm  
Purotouch<sup>®</sup>

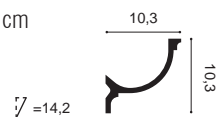

**C217 | C217F**

LUXXUS

200 x 10,3 x 15,6 cm  
Purotouch<sup>®</sup>

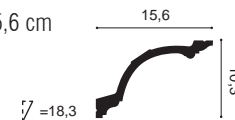

**C402 | C402F**

LUXXUS

200 x 10,7 x 9,4 cm  
Purotouch<sup>®</sup>

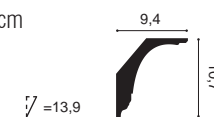

**C332**

LUXXUS

200 x 11,4 x 23 cm  
Purotouch<sup>®</sup>

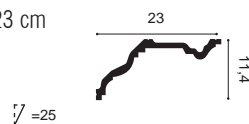

**C201 | C201F**

LUXXUS

200 x 11,6 x 4,8 cm  
Purotouch<sup>®</sup>

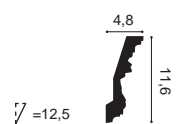

**C211 | C211F**

LUXXUS

200 x 11,6 x 11,2 cm  
Purotouch<sup>®</sup>

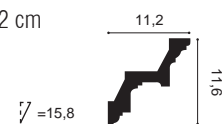

**C216 | C216F**

LUXXUS

200 x 11,6 x 13,3 cm  
Purotouch<sup>®</sup>

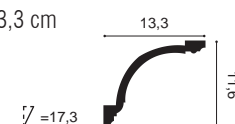



**C304 | C304F** LUXXUS

200 x 12,2 x 7,2 cm  
Purotouch<sup>®</sup>



**C333 | C333F** LUXXUS

200 x 12,2 x 11,1 cm  
Purotouch<sup>®</sup>

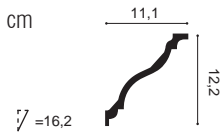

**C302 | C302F** LUXXUS

200 x 12,8 x 8,5 cm  
Purotouch<sup>®</sup>

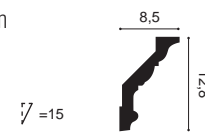

**C340** LUXXUS

200 x 13,5 x 25,6 cm  
Purotouch<sup>®</sup>

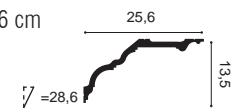

**C991 CURTAIN PROFILE**

200 x 14 x 11 cm  
Purotouch<sup>®</sup>  
Designed by  
Ulf Moritz

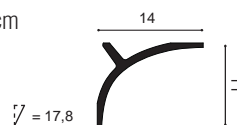

**C991**



**C991 + P9900**

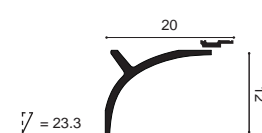

**C991 + 2x P9900**

ULF MORITZ

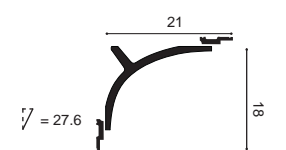





NEW

**C342 HERITAGE L**

LUXXUS

200 x 14 x 19 cm  
Purotouch<sup>®</sup>

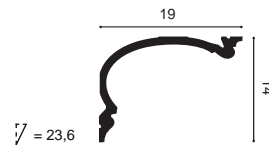

NEW

**C339 | C339F**

LUXXUS

200 x 14,1 x 6,4 cm  
Purotouch<sup>®</sup>

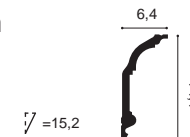

**C303 | C303F**

LUXXUS

200 x 14,4 x 6,5 cm  
Purotouch<sup>®</sup>

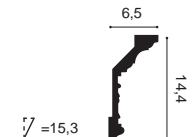

NEW

**C991**

200 x 11 x 14 cm  
Purotouch<sup>®</sup>  
Designed by  
Ulfi Moritz

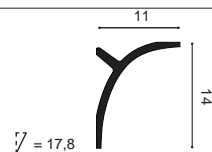

NEW

**C991 + P9900**

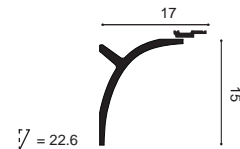

NEW

**C991 + 2x P9900**

ULF MORITZ

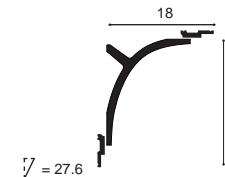

**C218 | C218F**

LUXXUS

200 x 15 x 12 cm  
Purotouch<sup>®</sup>

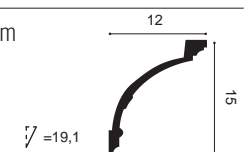



**C334 | C334F** LUXXUS

200 x 15 x 19,6 cm  
Purotouch<sup>®</sup>

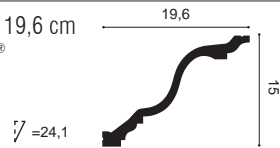

**C901 | C901F** LUXXUS

200 x 14,8 x 12,4 cm  
Purotouch<sup>®</sup>

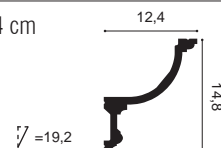

**C217 | C217F** LUXXUS

200 x 15,6 x 10,3 cm  
Purotouch<sup>®</sup>

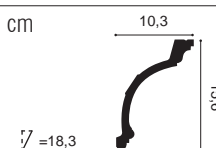

**C300** LUXXUS

200 x 16,5 x 13 cm  
Purotouch<sup>®</sup>

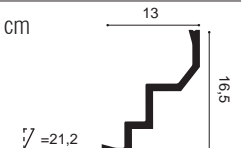

**C990 INFINITY**

200 x 15,9 x 21,6 cm  
Purotouch<sup>®</sup>  
Designed by  
Xavier Donck

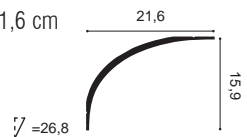

**C990 + P9900**

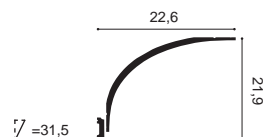

**C990 + 2x P9900**



**C990 + P9901** LUXXUS

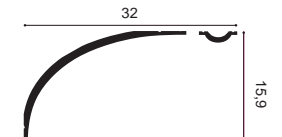



**C900** LUXXUS

200 x 17,1 x 14,6 cm  
Purotouch<sup>®</sup>

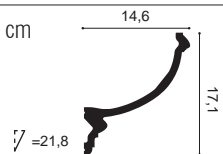

**C422** LUXXUS

200 x 16,4 x 19,4 cm  
Purotouch<sup>®</sup>

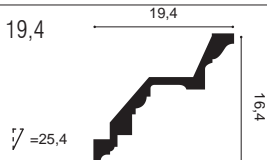

**C301 | C301F** LUXXUS

200 x 17 x 14,4 cm  
Purotouch<sup>®</sup>

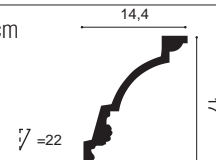

**C337** LUXXUS

200 x 17,2 x 25,6 cm  
Purotouch<sup>®</sup>

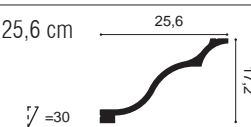

**C219** LUXXUS

200 x 17,6 x 13 cm  
Purotouch<sup>®</sup>

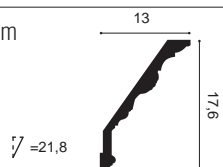

**C338** LUXXUS

200 x 18,4 x 18,4 cm  
Purotouch<sup>®</sup>

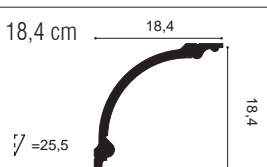

**C338A BA'ROCK** LUXXUS

200 x 18,4 x 18,4 cm  
Purotouch<sup>®</sup>

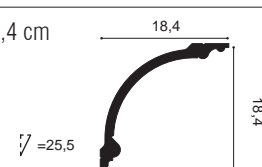

**C338B BA'ROCK** LUXXUS

200 x 18,4 x 18,4 cm  
Purotouch<sup>®</sup>

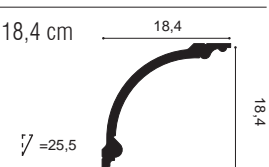



**C343 HERITAGE XL** LUXXUS

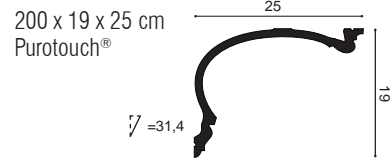

**C990 INFINITY**

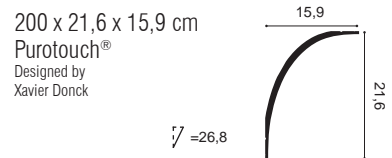

**C307** LUXXUS

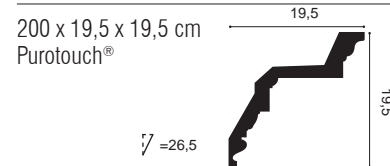

**C990 + P9900**

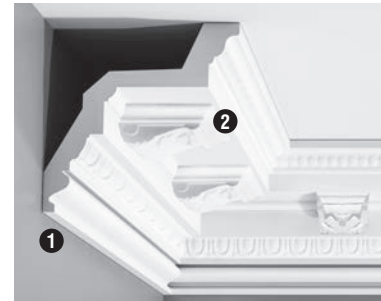

**1 C307 + C307A 2** LUXXUS

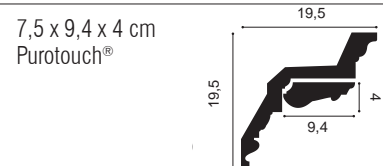

**C990 + 2x P9900**

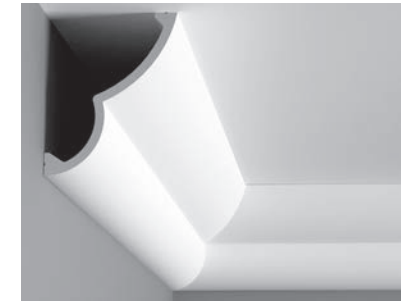
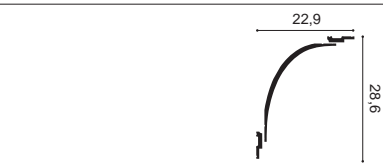

**C370 CLOUD** ULF MORITZ

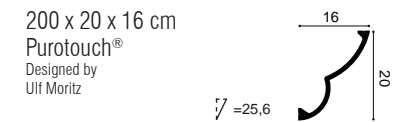

**C990 + P9901** LUXXUS

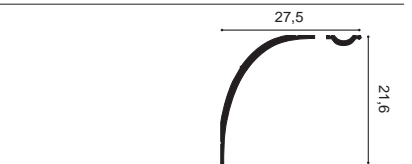

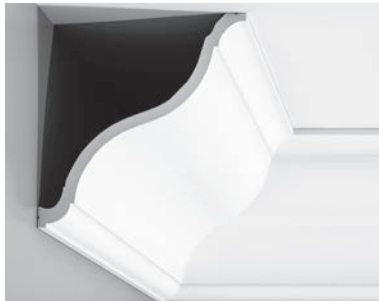

**C335** LUXXUS

200 x 20,2 x 22,2 cm  
Purotouch<sup>®</sup>  
Designed by  
Xavier Donck

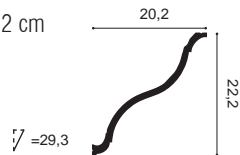

**C335** LUXXUS

200 x 22,2 x 20 cm  
Purotouch<sup>®</sup>  
Designed by  
Xavier Donck

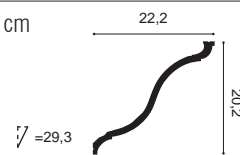

**C332** LUXXUS

200 x 23 x 11,4 cm  
Purotouch<sup>®</sup>

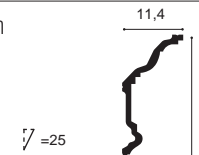

**C308 | C308F** LUXXUS

200 x 24,8 x 6,3 cm  
Purotouch<sup>®</sup>

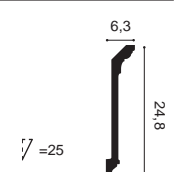

**C340** LUXXUS

200 x 25,6 x 13,5 cm  
Purotouch<sup>®</sup>

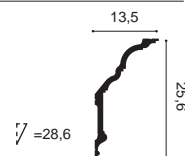

**C336** LUXXUS

200 x 27,1 x 26,6 cm  
Purotouch<sup>®</sup>

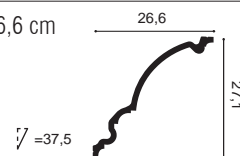

**C344 HERITAGE XXL** LUXXUS

200 x 27,3 x 35 cm  
Purotouch<sup>®</sup>

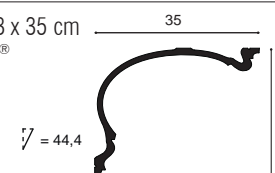



**DX162-2300**

AXXENT

230 x 1 x 4 cm  
Duopolymer<sup>®</sup>



**DX159-2300**

AXXENT

230 x 1,2 x 6 cm  
Duopolymer<sup>®</sup>



**CX160**

AXXENT

200 x 1,3 x 3,9 cm  
Duopolymer<sup>®</sup>



**DX157-2300 | DX157F**

AXXENT

230 x 6,6 x 1,3 cm (DX157-2300)  
200 x 6,6 x 1,3 cm (DX157F)  
Duopolymer<sup>®</sup>



**CX161**

AXXENT

200 x 1,3 x 6,9 cm  
Duopolymer<sup>®</sup>



**DX163-2300**

AXXENT

230 x 1,3 x 10,2 cm  
Duopolymer<sup>®</sup>



**DX168-2300**

AXXENT

230 x 1,4 x 15,1 cm  
Duopolymer<sup>®</sup>

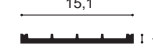

**CX132 | CX132F**

AXXENT

200 x 2 x 2 cm  
Duopolymer<sup>®</sup>

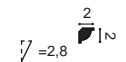

# Kroonlijsten / Corniches / Cornice Mouldings / Eckleisten / Cornisas



**CX133**

AXXENT

200 x 2 x 2 cm  
Duropolymer®

$\nabla = 2,7$  

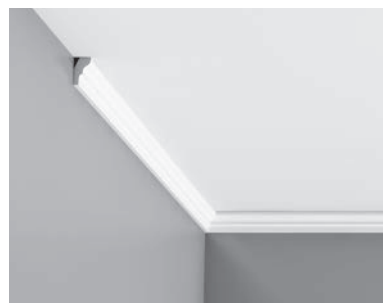

**CX111**

AXXENT

200 x 2,6 x 1,5 cm  
Duropolymer®

$\nabla = 2,8$  



**PX164**

AXXENT

200 x 2,4 x 3 cm  
Duropolymer®

$\nabla = 3,9$  



**CX115**

AXXENT

200 x 3 x 2,9 cm  
Duropolymer®

$\nabla = 3,9$  

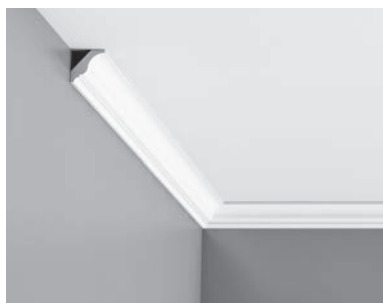

**CX154**

AXXENT

200 x 3 x 3 cm  
Duropolymer®

$\nabla = 4,1$  

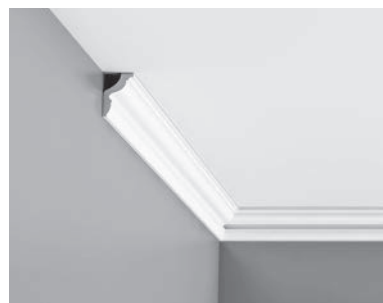

**CX148 | CX148F**

AXXENT

200 x 4,3 x 2,9 cm  
Duropolymer®

$\nabla = 5,1$  



**CX149**

AXXENT

200 x 4,3 x 2,9 cm  
Duropolymer®

$\nabla = 5,1$  



**CX150**

AXXENT

200 x 4,3 x 2,9 cm  
Duropolymer®

$\nabla = 5,1$  

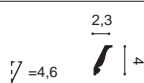

**CX151** AXSENT  
200 x 4,0 x 2,3 cm  
Duropolymer<sup>®</sup>  
∠ = 4,6 

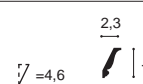

**CX152** AXSENT  
200 x 4,0 x 2,3 cm  
Duropolymer<sup>®</sup>  
∠ = 4,6 

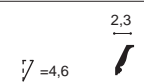

**CX153** AXSENT  
200 x 4,0 x 2,3 cm  
Duropolymer<sup>®</sup>  
∠ = 4,6 

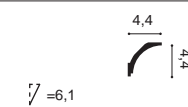

**CX109 | CX109F** AXSENT  
200 x 4,4 x 4,4 cm  
Duropolymer<sup>®</sup>  
∠ = 6,1 

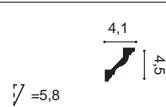

**CX110 | CX110F** AXSENT  
200 x 4,5 x 4,1 cm  
Duropolymer<sup>®</sup>  
∠ = 5,8 

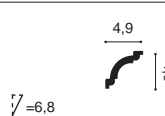

**CX124 | CX124F** AXSENT  
200 x 4,9 x 4,9 cm  
Duropolymer<sup>®</sup>  
∠ = 6,8 

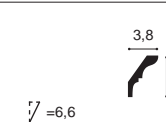

**CX112** AXSENT  
200 x 5,4 x 3,8 cm  
Duropolymer<sup>®</sup>  
∠ = 6,6 

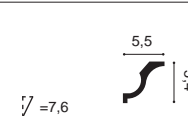

**CX108** AXSENT  
200 x 5,4 x 5,5 cm  
Duropolymer<sup>®</sup>  
∠ = 7,6 



# Kroonlijsten / Corniches / Cornice Mouldings / Eckleisten / Cornisas



**CX141** AXXENT  
200 x 5,9 x 3,1 cm  
Duropolymer<sup>®</sup>  
∠ = 6,7

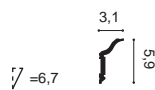

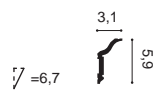

**CX142** AXXENT  
200 x 5,9 x 3,1 cm  
Duropolymer<sup>®</sup>  
∠ = 6,7



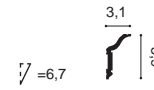

**CX143** AXXENT  
200 x 5,9 x 3,1 cm  
Duropolymer<sup>®</sup>  
∠ = 6,7

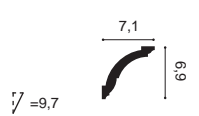



**CX100 | CX100F** AXXENT  
200 x 6,9 x 7,1 cm  
Duropolymer<sup>®</sup>  
∠ = 9,7

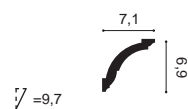



**CX101** AXXENT  
200 x 6,9 x 7,1 cm  
Duropolymer<sup>®</sup>  
∠ = 9,7





**CX136** AXXENT  
200 x 6,9 x 7,1 cm  
Duropolymer<sup>®</sup>  
∠ = 9,7

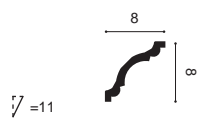
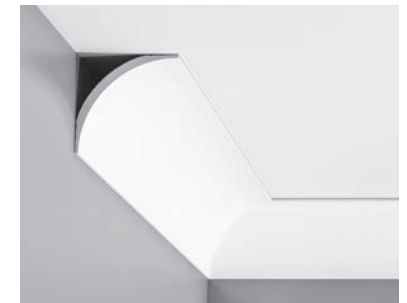

**CX123** AXXENT  
200 x 8 x 8 cm  
Duropolymer<sup>®</sup>  
∠ = 11

**CX126** AXXENT  
200 x 8,7 x 8,7 cm  
Duropolymer<sup>®</sup>  
∠ = 12,2

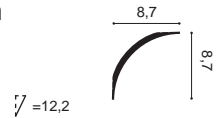



**CX127 | CX127F** AXXENT

200 x 9,4 x 9,4 cm  
Duropolymer<sup>®</sup>

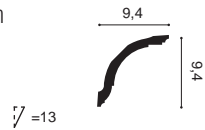

**CX128** AXXENT

200 x 9,4 x 9,4 cm  
Duropolymer<sup>®</sup>

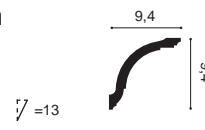

**CX106** AXXENT

200 x 11,8 x 11,7 cm  
Duropolymer<sup>®</sup>

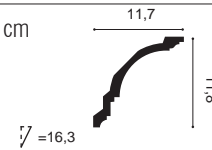

**CX129** AXXENT

200 x 9,4 x 9,4 cm  
Duropolymer<sup>®</sup>

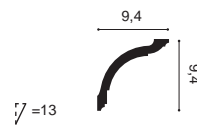

**CX107** AXXENT

200 x 11,8 x 11,7 cm  
Duropolymer<sup>®</sup>

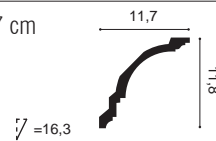

# Kroonlijsten / Corniches / Cornice Mouldings / Eckleisten / Cornisas



**CB500** BASIXX  
200 x 2,5 x 1,8 cm  
Durofoam<sup>®</sup>  
1,8  
2,5  
∇ = 3



**CB530** BASIXX  
200 x 2,7 x 1,5 cm  
Durofoam<sup>®</sup>  
1,5  
2,7  
∇ = 3,2



**CB520** BASIXX  
200 x 3,5 x 3,5 cm  
Durofoam<sup>®</sup>  
3,5  
3,5  
∇ = 5



**CB510** BASIXX  
200 x 4 x 4 cm  
Durofoam<sup>®</sup>  
4  
4  
∇ = 5,6



**CB501** BASIXX  
200 x 4,1 x 3,5 cm  
Durofoam<sup>®</sup>  
3,5  
4,1  
∇ = 5,3



**CB531** BASIXX  
200 x 4,2 x 2,6 cm  
Durofoam<sup>®</sup>  
2,6  
4,2  
∇ = 5,2



**CB521** BASIXX  
200 x 5 x 5 cm  
Durofoam<sup>®</sup>  
5  
5  
∇ = 7,1



**CB523** BASIXX  
200 x 5,9 x 4,4 cm  
Durofoam<sup>®</sup>  
4,4  
5,9  
∇ = 7,2



**CB502** BASIXX  
200 x 5,9 x 4,9 cm  
Durofoam<sup>®</sup>  
4,9  
5,9  
∇ = 7,8



**CB511** BASIXX  
200 x 6,7 x 6,7 cm  
Durofoam<sup>®</sup>  
6,7  
6,7  
∇ = 9,8



**CB522** BASIXX  
200 x 6,7 x 6,7 cm  
Durofoam<sup>®</sup>  
6,7  
6,7  
∇ = 9,7



**CB503** BASIXX  
200 x 8,2 x 9,2 cm  
Durofoam<sup>®</sup>  
9,2  
8,2  
∇ = 12,3



**CB512** BASIXX  
200 x 10 x 10 cm  
Durofoam<sup>®</sup>  
10  
10  
∇ = 13,8



**PB513** BASIXX  
200 x 3,4 x 1,5 cm  
Durofoam<sup>®</sup>  
3,4  
1,5  
∇ = 1,5

# ORAC FLEX (REF + F)

Kroonlijsten / Corniches / Cornice Mouldings / Eckleisten / Cornisas

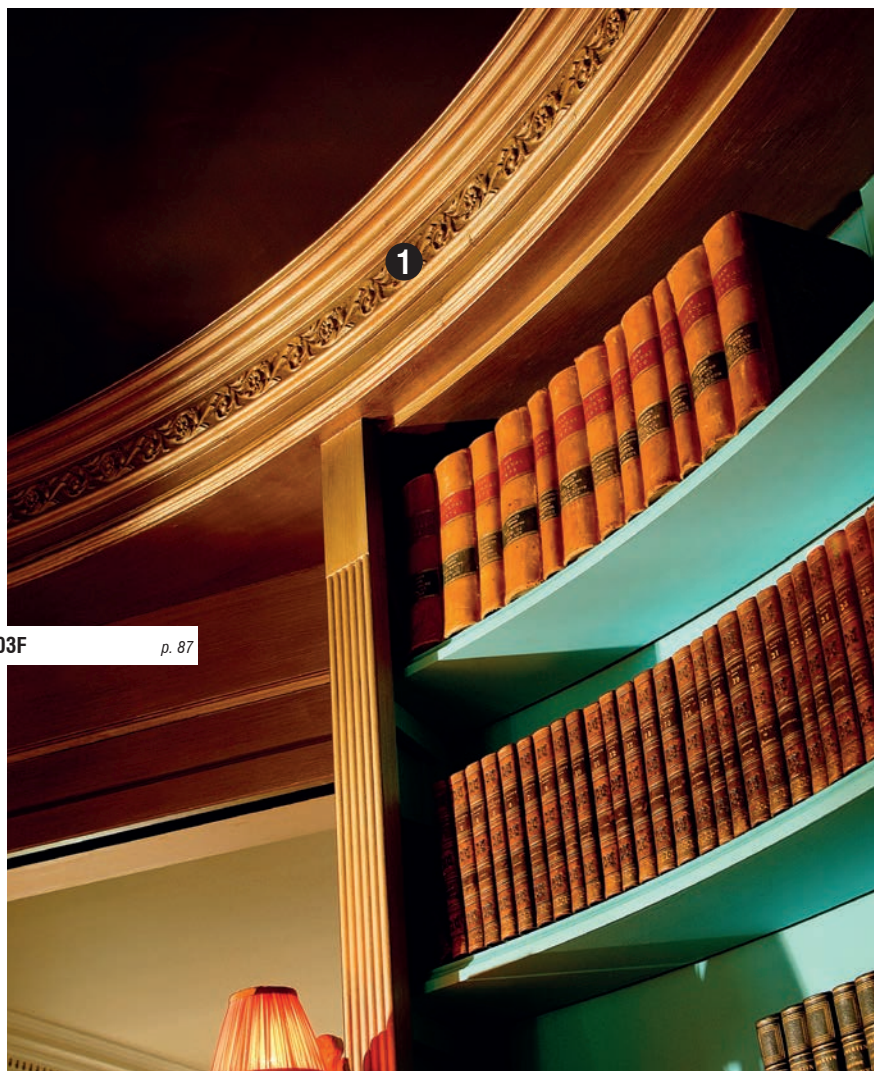

1 C303F p. 87

LUXXUS	cm		cm
	R min	<b>C339F</b>	380
<b>C200F</b>	160	<b>C341F</b>	400
<b>C201F</b>	200	<b>C373F</b>	100
<b>C211F</b>	250	<b>C374F</b>	130
<b>C212F</b>	120	<b>C402F</b>	300
<b>C213F</b>	280	<b>C602F</b>	100
<b>C214F</b>	140	<b>C901F</b>	600
<b>C215F</b>	160	<b>C902F</b>	600
<b>C216F</b>	340		
<b>C217F</b>	380		
<b>C218F</b>	360		
<b>C220F</b>	400		
<b>C230F</b>	150		
<b>C240F</b>	270		
<b>C250F</b>	70		
<b>C260F</b>	130		
<b>C301F</b>	320		
<b>C302F</b>	250		
<b>C303F</b>	180		
<b>C304F</b>	250		
<b>C308F</b>	120		
<b>C321F</b>	140		
<b>C322F</b>	160		
<b>C331F</b>	420		
<b>C333F</b>	300		
<b>C334F</b>	380		
		<b>AXXENT</b>	cm
			R min
		<b>CX100F</b>	200
		<b>CX109F</b>	160
		<b>CX110F</b>	180
		<b>CX124F</b>	160
		<b>CX127F</b>	240
		<b>CX132F</b>	70
		<b>CX148F</b>	180

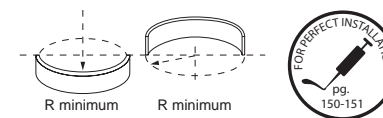



- |   |              |       |
|---|--------------|-------|
| 1 | C370 + C370A | p. 90 |
| 2 | C354         | p. 82 |



## nl

Een vlakke muur tot leven brengen. Wallscaping noemen wij dat. Met de uitgebreide keuze aan wandlijsten creëer je in een oogwenk een lambrisering of kader op muur en plafond. Bovendien zijn ze eenvoudig te plaatsen en veelal in flexibele uitvoering beschikbaar.

## fr

Animer un mur uni, c'est ce que nous appelons le « wallscaping ». Le vaste choix de cimaises permet de créer en un clin d'œil un lambris ou un encadrement sur le mur ou le plafond. Elles sont en outre faciles à poser et bon nombre d'entre elles sont disponibles en version flexible.

## en

Make flat walls come to life using "wallscaping" with our extensive panel mould range. Create attractive panelling or frames on walls and ceilings in a jiffy. All designs are easy to install, and many are available in a flexible format for use on curved walls and ceilings.

## de

Einer flachen Wand Leben einhauchen. Das nennen wir "Wallscaping". Mit Hilfe der breiten Auswahl an Wandleisten gestalten Sie im Handumdrehen eine Wandvertäfelung oder Wand- und Deckenspiegel. Darüber hinaus lassen sich die Leisten einfach anbringen und sind die auch in flexibler Ausführung verfügbar.

## es

Dar vida a una pared plana: nosotros lo llamamos «wallscaping». Con nuestra extensa gama de molduras usted podrá crear paneles o marcos atractivos en sus paredes o techos en un instante. Además, son fáciles de instalar y están disponibles en una gran variedad de versiones flexibles.

Wandlijsten  
Cimaises  
Panel Mouldings  
Wand - und Friesleisten  
Molduras



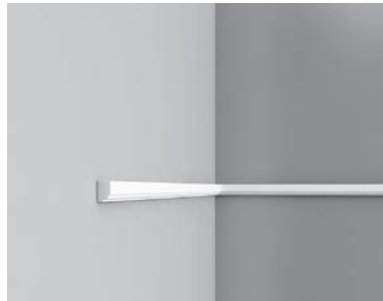

**P9050 | P9050F** LUXXUS

200 x 2,5 x 1,3 cm  
Purotouch<sup>®</sup>



**P5021 | P5021F** LUXXUS

200 x 3,1 x 0,9 cm  
Purotouch<sup>®</sup>



**P8030 | P8030F** LUXXUS

200 x 4,1 x 1,7 cm  
Purotouch<sup>®</sup>

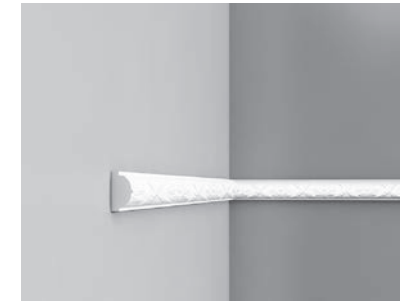

**P2020 | P2020F** LUXXUS

200 x 4,4 x 2,6 cm  
Purotouch<sup>®</sup>



**P1020 | P1020F** LUXXUS

200 x 4,9 x 2,4 cm  
Purotouch<sup>®</sup>



**P9040 | P9040F** LUXXUS

200 x 5 x 2,5 cm  
Purotouch<sup>®</sup>



**P4020 | P4020F** LUXXUS

200 x 5 x 2,9 cm  
Purotouch<sup>®</sup>



**P8060 | P8060F** LUXXUS

200 x 5 x 3,5 cm  
Purotouch<sup>®</sup>







**P8020 | P8020F**

LUXXUS

200 x 6 x 2,6 cm  
Purotouch<sup>®</sup>



**P3020 | P3020F**

LUXXUS

200 x 6,1 x 3,2 cm  
Purotouch<sup>®</sup>

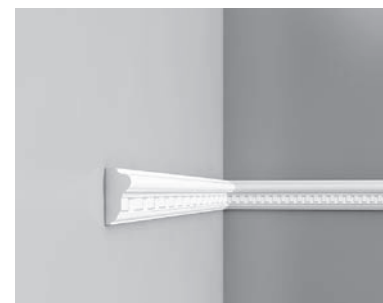

**P6020 | P6020F**

LUXXUS

200 x 6,4 x 2,8 cm  
Purotouch<sup>®</sup>



**P9901 | P9901F**

LUXXUS

200 x 7 x 1,4 cm  
Purotouch<sup>®</sup>



**P7070 | P7070F**

LUXXUS

200 x 7,4 x 2,2 cm  
Purotouch<sup>®</sup>

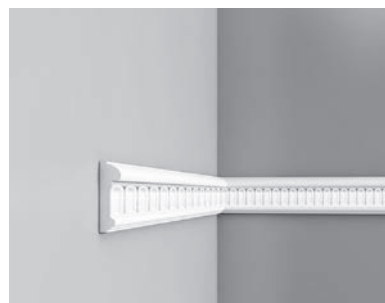

**P7040 | P7040F**

LUXXUS

200 x 7,9 x 2,6 cm  
Purotouch<sup>®</sup>



**P9900 | P9900F**

LUXXUS

200 x 8 x 1 cm  
Purotouch<sup>®</sup>



**P5051**

LUXXUS

200 x 8,4 x 1,5 cm  
Purotouch<sup>®</sup>  
Designed by  
Jacques Vergracht





**P7030 | P7030F**

LUXXUS

200 x 8,5 x 1,7 cm  
Purotouch<sup>®</sup>

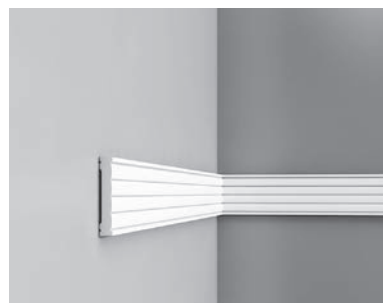

**P5020 | P5020F**

LUXXUS

200 x 9,1 x 1,3 cm  
Purotouch<sup>®</sup>



**P9010 | P9010F**

LUXXUS

200 x 9,1 x 3 cm  
Purotouch<sup>®</sup>



**DX119-2300**

LUXXUS

230 x 9,2 x 2,2 cm  
Duropolymer<sup>®</sup>



**DX121-2300**

LUXXUS

230 x 9,4 x 2,3 cm  
Duropolymer<sup>®</sup>

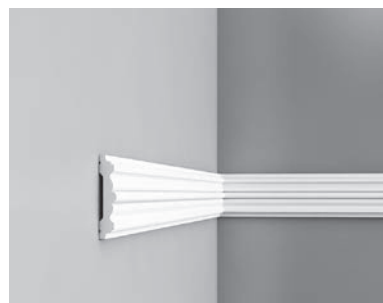

**P9020 | P9020F**

LUXXUS

200 x 9,6 x 2,1 cm  
Purotouch<sup>®</sup>

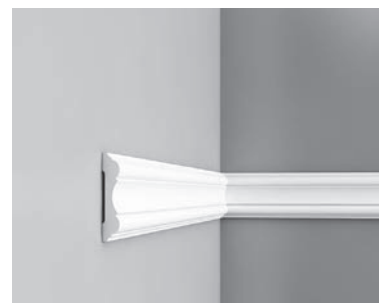

**P8040 | P8040F**

LUXXUS

200 x 10,1 x 2,2 cm  
Purotouch<sup>®</sup>



**P7010 | P7010F**

LUXXUS

200 x 10,5 x 2 cm  
Purotouch<sup>®</sup>





**P7020 | P7020F**

LUXXUS

200 x 11,1 x 1,9 cm  
Purotouch<sup>®</sup>



**DX170-2300 HERITAGE**

LUXXUS

230 x 11,9 x 3,2 cm  
Duropolymer<sup>®</sup>



p. 128



**P8050 | P8050F**

LUXXUS

200 x 12 x 3 cm  
Purotouch<sup>®</sup>

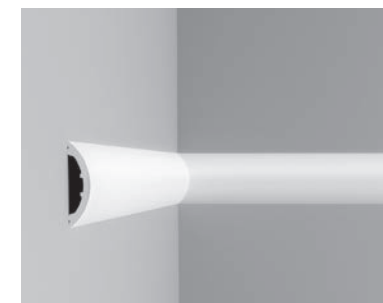

**P3070 RADIUS**

ULF MORITZ

200 x 12,5 x 3,2 cm  
Purotouch<sup>®</sup>  
Designed by  
Ulf Moritz



**P5050**

LUXXUS

200 x 20 x 1,5 cm  
Purotouch<sup>®</sup>  
Designed by  
Jacques Vergracht



**P7080**

LUXXUS

200 x 21,8 x 2,9 cm  
Purotouch<sup>®</sup>

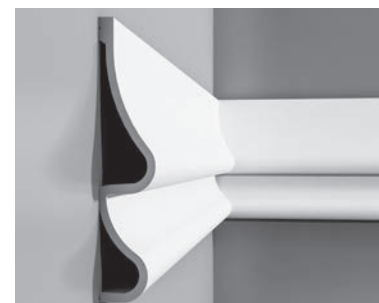

**P3071 GOLF**

ULF MORITZ

200 x 37,2 x 7,6 cm  
Purotouch<sup>®</sup>  
Designed by  
Ulf Moritz





**PX103 | PX103F** AXSENT  
200 x 2,5 x 1,2 cm  
Duopolymer<sup>®</sup> 1,2 | 2,5



**PX116** AXSENT  
200 x 3,1 x 1 cm  
Duopolymer<sup>®</sup> 1 | 3,1

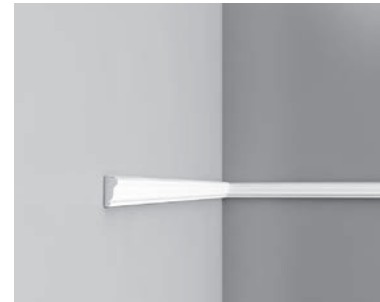

**PX117** AXSENT  
200 x 3,5 x 1,5 cm  
Duopolymer<sup>®</sup> 1,5 | 3,5



**DX162-2300** AXSENT  
230 x 4 x 1 cm  
Duopolymer<sup>®</sup> 1 | 4  
 p. 128



**PX120 | PX120F** AXSENT  
200 x 4 x 1,9 cm  
Duopolymer<sup>®</sup> 1,9 | 4

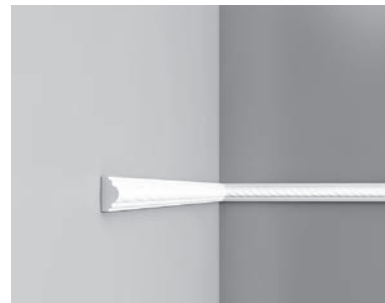

**PX131** AXSENT  
200 x 4 x 1,9 cm  
Duopolymer<sup>®</sup> 1,9 | 4



**PX144 | PX144F** AXSENT  
200 x 4,7 x 0,8 cm  
Duopolymer<sup>®</sup> 0,8 | 4,7



**PX145** AXSENT  
200 x 4,7 x 0,8 cm  
Duopolymer<sup>®</sup> 0,8 | 4,7



**PX146**

AXXENT

200 x 4,7 x 0,8 cm  
Duropolymer<sup>®</sup>



**PX113**

AXXENT

200 x 6 x 2,7 cm  
Duropolymer<sup>®</sup>



**PX114**

AXXENT

200 x 6 x 2,7 cm  
Duropolymer<sup>®</sup>

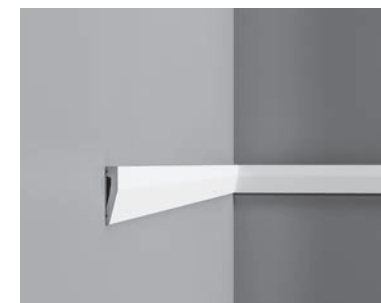

**DX159-2300**

AXXENT

230 x 6 x 1,2 cm  
Duropolymer<sup>®</sup>



p. 128



**DX157-2300 | DX157F**

AXXENT

230 x 6,6 x 1,3 cm (DX157-2300)  
200 x 6,6 x 1,3 cm (DX157F)  
Duropolymer<sup>®</sup>



p. 128



**PX102**

AXXENT

200 x 7,9 x 1,6 cm  
Duropolymer<sup>®</sup>

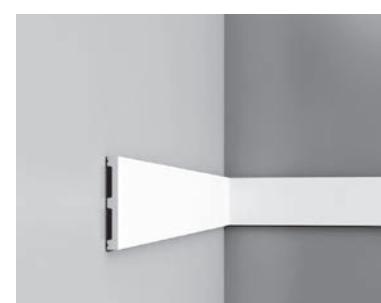

**DX163-2300**

AXXENT

230 x 10,2 x 1,3 cm  
Duropolymer<sup>®</sup>



p. 128



**DX168-2300**

AXXENT

230 x 15,1 x 1,4 cm  
Duropolymer<sup>®</sup>

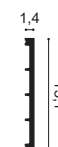

p. 128

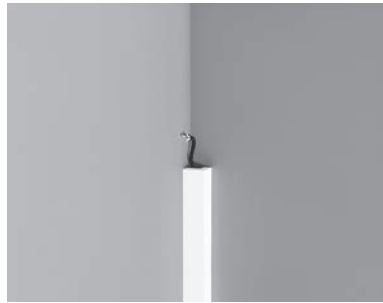

**PX164**

AXXENT

200 x 2,4 x 3 cm  
Duropolymer<sup>®</sup>



**PX147**

200 x 16,9 x 0,9 cm  
Duropolymer<sup>®</sup>

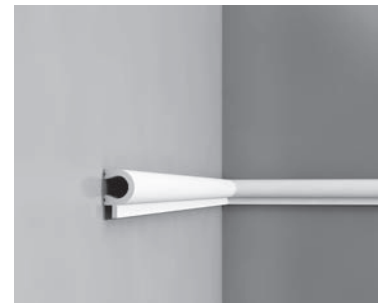
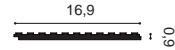

**PX169**

200 x 5,5 x 3,4 cm  
Duropolymer<sup>®</sup>

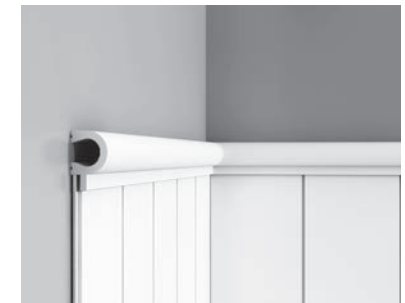

**PX147 + PX169**

AXXENT

Duropolymer<sup>®</sup>



**CX134**

AXXENT

200 x 3 x 3 cm  
Duropolymer<sup>®</sup>

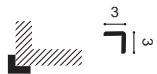

- |   |            |        |
|---|------------|--------|
| 1 | PX164      | p. 108 |
| 2 | DX163-2300 | p. 107 |
| 3 | DX157-2300 | p. 107 |
| 4 | DX163-2300 | p. 107 |
| 5 | DX162-2300 | p. 106 |



1 P8030C + P8030 2

19 x 8,6 x 1,7 cm  
Duropolymer<sup>®</sup>



P8030D

LUXXUS

13,2 x 13,2 x 1,7 cm  
Duropolymer<sup>®</sup>



1 P801C + P8020 2

LUXXUS

19,8 x 11 x 2,6 cm  
Purotouch<sup>®</sup>



P4020A + P4020

LUXXUS

16,4 x 9,1 x 2,9 cm  
Purotouch<sup>®</sup>

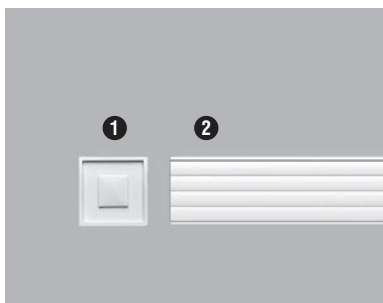

1 P5020B + P5020 2

LUXXUS

9 x 9 x 1,3 cm  
Purotouch<sup>®</sup>

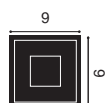

1 P21

LUXXUS

6,7 x 6,7 x 0,9 cm  
Purotouch<sup>®</sup>

2 P201A + P2020 3

LUXXUS

19,5 x 19,5 x 2,6 cm  
Purotouch<sup>®</sup>

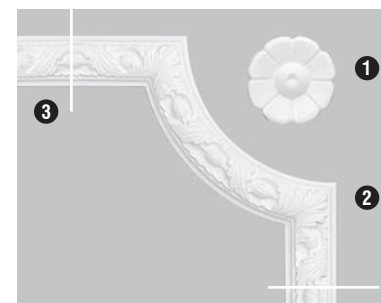

1 P20

LUXXUS

Ø 6,1 x 0,8 cm  
Duropolymer<sup>®</sup>

2 P101A + P1020 3

LUXXUS

24,5 x 24,5 x 2,4 cm  
Purotouch<sup>®</sup>

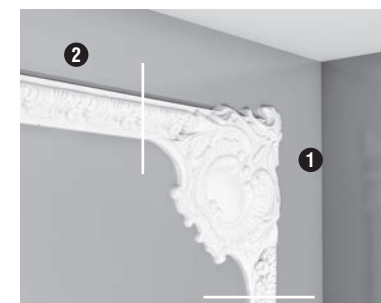

1 P3020A + P3020 2

LUXXUS

42,5 x 42,5 x 4 cm  
Purotouch<sup>®</sup>



1 PX120A + PX120 2 AXSENT

19 x 8,8 x 2 cm  
Duropolymer®



1 PX103A + PX103 2 AXSENT

19 x 3,5 x 1,2 cm  
Duropolymer®



- |          |        |
|----------|--------|
| 1 C217   | p. 85  |
| 2 P8030D | p. 109 |
| 3 P8030  | p. 102 |
| 4 P9010  | p. 104 |
| 5 SX118  | p. 116 |



# ORAC FLEX (REF + F)

Wandlijsten / Cimaises / Panel Mouldings / Wand - und Friesleisten / Molduras



AXXENT	cm	cm
	R min	R* min
<b>DX157F</b>	35	260
<b>PX103F</b>	20	80
<b>PX120F</b>	30	110
<b>PX144F</b>	20	220

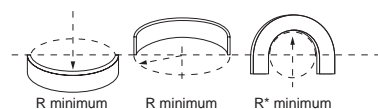

LUXXUS	cm	cm
	R min	R* min
<b>P1020F</b>	30	80
<b>P2020F</b>	30	80
<b>P3020F</b>	50	180
<b>P4020F</b>	40	200
<b>P5020F</b>	30	
<b>P5021F</b>	20	70
<b>P6020F</b>	30	250
<b>P7010F</b>	20	

	cm	cm	cm	cm
	R min	R* min	R min	R* min
<b>P7020F</b>	30		<b>P8060F</b>	80 200
<b>P7030F</b>	30	250	<b>P9010F</b>	40 310
<b>P7040F</b>	40	320	<b>P9020F</b>	30
<b>P7070F</b>	30	230	<b>P9040F</b>	30 80
<b>P8020F</b>	40	130	<b>P9050F</b>	20 60
<b>P8030F</b>	20	70	<b>P9900F</b>	20 250
<b>P8040F</b>	30		<b>P9901F</b>	20 180
<b>P8050F</b>	80	200		



## nl

Alle plinten bestaan uit Duropolymer<sup>®</sup>, een schok- en waterbestendige polymeermix die 100% recycleerbaar is. Kabels kun je makkelijk verbergen en de flexibele varianten laten toe om gebogen wanden elegant af te werken. De plinten zijn bovendien van een grondlaag voorzien en makkelijk overschilderbaar.

## fr

Toutes les plinthes sont en Duropolymer<sup>®</sup>, un mélange polymère résistant à l'eau et aux impacts qui est 100 % recyclable. Elles permettent d'aisément dissimuler les câbles, et les variantes flexibles sont idéales pour une finition élégante de murs cintrés. Par ailleurs, les plinthes sont livrées avec une couche de peinture primaire et peuvent facilement être mises en peinture.

## en

All skirting boards are made from Duropolymer<sup>®</sup>, an impact- and water-resistant polymer mix that is fully recyclable. Cables can be hidden easily, and the flexible versions allow curved walls to be finished elegantly. The skirting boards are pre-primed for easy painting.

## de

Alle Sockelleisten bestehen aus Duropolymer<sup>®</sup>, einer schlag- und wasserfesten Polymermischung, die zu 100 % recycelbar ist. Kabel können ganz einfach verdeckt verlegt werden und mit den flexiblen Ausführungen lassen sich auch gekrümmte Wände elegant verschönern. Die Sockelleisten sind werkseitig grundiert und lassen sich farblich individuell und einfach beschichten.

## es

Todos los zócalos están fabricados con Duropolymer<sup>®</sup>, una mezcla de polímeros totalmente reciclable, resistente al agua y a los golpes. Los cables pueden esconderse fácilmente y las versiones flexibles permiten dar un acabado elegante a las paredes curvas. Los zócalos se entregan con una imprimación de fábrica listos para ser pintados de una manera fácil.

Plinten  
Plinthes  
Skirting  
Sockelleisten  
Zócalos





**CX132 | CX132F**

AXXENT

200 x 2 x 2 cm  
 Duropolymer<sup>®</sup>



**CX133**

AXXENT

200 x 2 x 2 cm  
 Duropolymer<sup>®</sup>



**DX162-2300**

AXXENT

230 x 4 x 1 cm  
 Duropolymer<sup>®</sup>



**DX159-2300**

AXXENT

230 x 6 x 1,2 cm  
 Duropolymer<sup>®</sup>

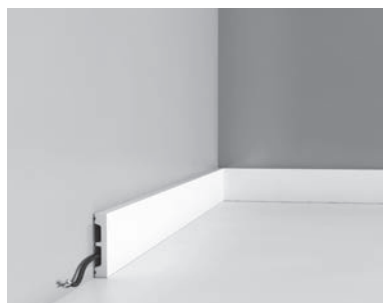

**DX157-2300 | DX157F**

AXXENT

230 x 6,6 x 1,3 cm (DX157-2300)  
 200 x 6,6 x 1,3 cm (DX157F)  
 Duropolymer<sup>®</sup>

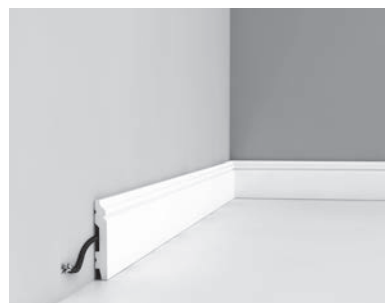

**SX165 | SX165F**

AXXENT

200 x 6,9 x 1,1 cm  
 Duropolymer<sup>®</sup>

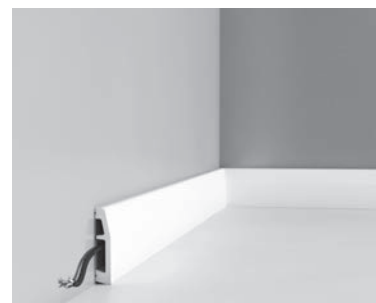

**SX125**

AXXENT

200 x 6,9 x 1,4 cm  
 Duropolymer<sup>®</sup>



**SX122**

AXXENT

200 x 7,9 x 2,2 cm  
 Duropolymer<sup>®</sup>



Plinten / Plinthes / Skirting  
 Sockelleisten / Zócalos



**SX137**

AXXENT

200 x 9,9 x 1,5 cm  
 Duropolymer<sup>®</sup>



**DX163-2300**

AXXENT

230 x 10,2 x 1,3 cm  
 Duropolymer<sup>®</sup>



**SX105 | SX105F**

LUXXUS

200 x 10,8 x 1,3 cm  
 Duropolymer<sup>®</sup>

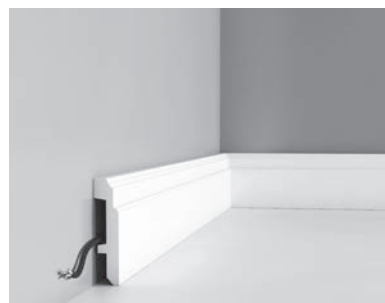

**SX155 | SX155F**

LUXXUS

200 x 10,8 x 2,5 cm  
 Duropolymer<sup>®</sup>



1 SX118

p. 116

1



**SX138**

AXXENT

200 x 13,8 x 1,5 cm  
 Duropolymer<sup>®</sup>



**SX118 | SX118F**

LUXXUS

200 x 13,8 x 1,8 cm  
 Duropolymer<sup>®</sup>



**SX104**

LUXXUS

200 x 14,8 x 1,7 cm  
 Duropolymer<sup>®</sup>



**DX168-2300**

AXXENT

230 x 15,1 x 1,4 cm  
 Duropolymer<sup>®</sup>

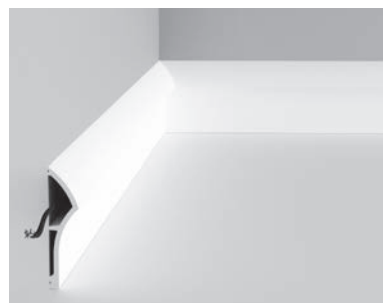

**SX167 DUNE**

ULF MORITZ

200 x 17,3 x 4,3 cm  
 Duropolymer<sup>®</sup>  
 Designed by Ulf Moritz

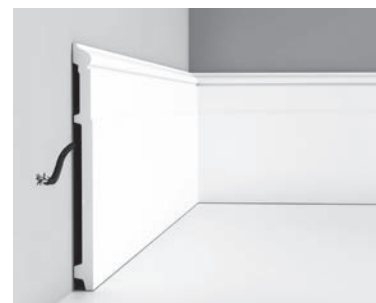
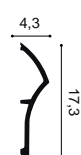

**SX156 HIGH HEELS**

LUXXUS

200 x 20 x 1,6 cm  
 Duropolymer<sup>®</sup>  
 Designed by  
 Xavier Donck



# ORAC FLEX (REF + F)

Plinten / Plinthes / Skirting / Sockelleisten / Zócalos



p. 116



**LUXXUS** cm

R min

<b>SX105F</b>	30
<b>SX118F</b>	40
<b>SX155F</b>	30

**AXXENT** cm

R min

R\* min

<b>CX132F</b>	70	
<b>DX157F</b>	35	260
<b>SX165F</b>	40	

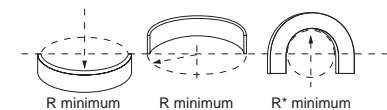



## nl

Indirecte verlichting is een echte sfeermaker en creëert een extra ruimtelijk effect. Van lineair strak tot organisch, als up- of downlighter, één ding is zeker: ze versterkt de architectuur. Dankzij de compacte LED-verlichting heb je bovendien een energiezuinige oplossing en is een lange levensduur gegarandeerd.

## fr

Incontournable pour l'ambiance, l'éclairage indirect crée une illusion d'espace supplémentaire. Qu'il soit linéaire ou organique, à luminosité vers le bas ou vers le haut, l'éclairage indirect souligne indubitablement l'architecture. Grâce à l'éclairage LED compact, vous disposez en outre d'une solution économique dont la longévité est garantie.

## en

Indirect lighting imparts a warm atmosphere and creates an extra spatial effect. Whether tautly linear or diffuse, as uplight or downlight, one thing is certain: it enhances the architecture. What's more, the compact LED lighting ensures an energy-efficient and durable solution.

## de

Indirekte Beleuchtung sorgt für eine besondere Atmosphäre und schafft einen zusätzlichen räumlichen Effekt. Von linear bis organisch, mit auf- oder abwärts strahlendem Licht: der gesamte Raum gewinnt durch das Spiel von Licht und Schatten. Und Dank der kompakten LED-Beleuchtung sind eine hohe Energieeffizienz und eine lange Lebensdauer garantiert. Eines ist in jedem Fall sicher: Beleuchtung unterstreicht die Architektur, Farben und Oberflächenstrukturen.

## es

La iluminación indirecta aporta una atmósfera cálida y crea un efecto de amplitud espacial. Ya sea una iluminación rectilínea o difusa, desde arriba o desde abajo, una cosa queda clara: realza la arquitectura del espacio interior. Además, la iluminación de los LED compactos garantiza una solución duradera y energéticamente eficiente.



Indirecte Verlichting  
Éclairage Indirect  
Indirect Lighting  
Indirekte Beleuchtung  
Iluminación Indirecta





**C351 BOAT** LUXXUS

200 x 7,4 x 17,3 cm  
 Purotouch<sup>®</sup>  
 Designed by  
 Jacques Vergracht

$\text{r} = 19$

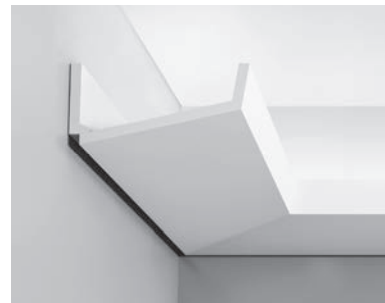

**C352 FLAT** LUXXUS

200 x 7,6 x 17,1 cm  
 Purotouch<sup>®</sup>  
 Designed by  
 Jacques Vergracht

$\text{r} = 18,1$



**C357 STRAIGHT** LUXXUS

200 x 7,1 x 11 cm  
 Purotouch<sup>®</sup>  
 Designed by  
 Jacques Vergracht

$\text{r} = 12,6$

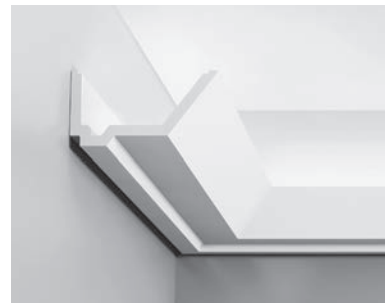

**C358 RAIL** LUXXUS

200 x 7,3 x 14 cm  
 Purotouch<sup>®</sup>  
 Designed by  
 Jacques Vergracht

$\text{r} = 15,3$

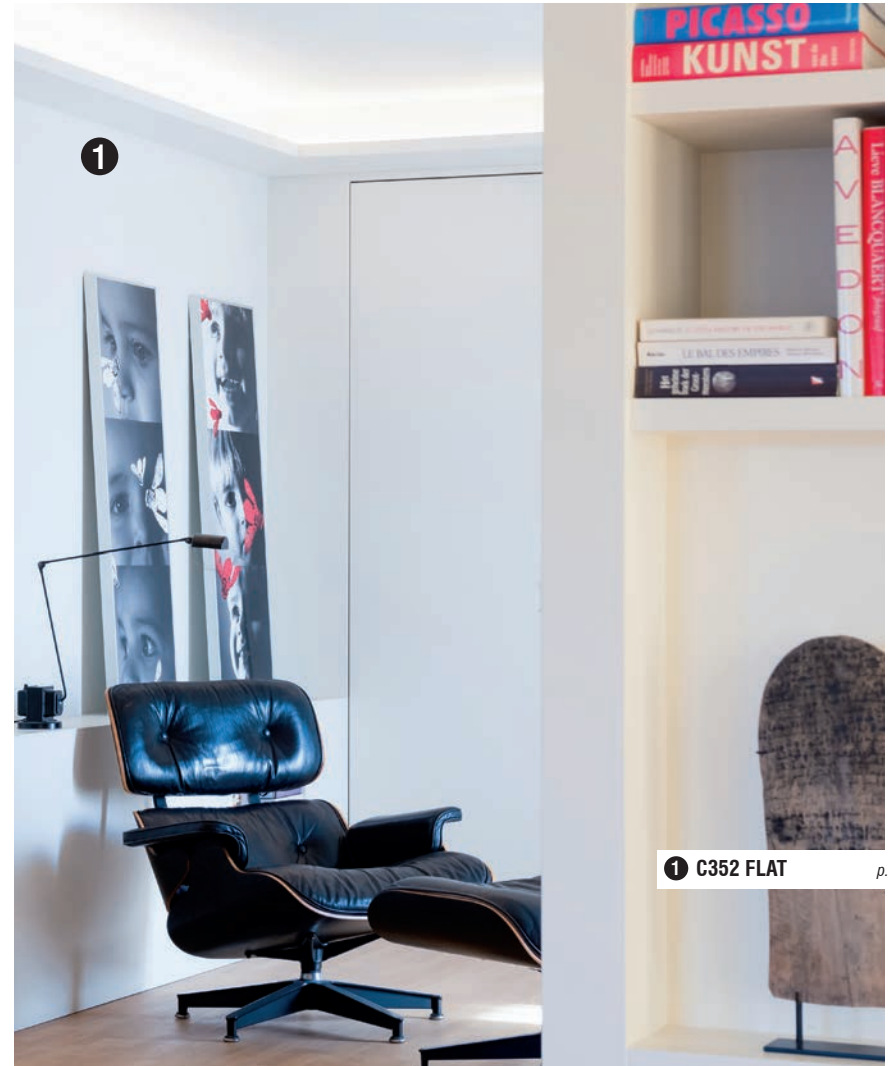

**1 C352 FLAT** p. 120



1 C364 WAVE p. 121



**C361 STRIPE** LUXXUS

200 x 5 x 5 cm  
 Purotouch<sup>®</sup>  
 Designed by  
 Pierre Daems

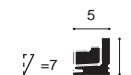

**C364 WAVE** LUXXUS

200 x 14 x 8 cm  
 Purotouch<sup>®</sup>  
 Designed by  
 Pierre Daems  
 Red Dot Design Award 2014

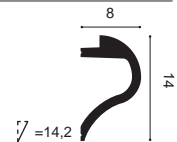

**C362 CURVE** LUXXUS

200 x 5 x 5 cm  
 Purotouch<sup>®</sup>  
 Designed by  
 Pierre Daems

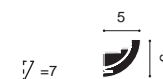



- 1 C991 *p. 70*
- 2 C374 ANTONIO *p. 123*
- 3 C373 ANTONIO *p. 123*
- 4 SX167 DUNE *p. 116*



1 C373 ANTONIO *p. 123*



**C373 | C373F ANTONIO** ULF MORITZ

200 x 8 x 5 cm  
 Purotouch<sup>®</sup>  
 Designed by  
 Ulf Moritz

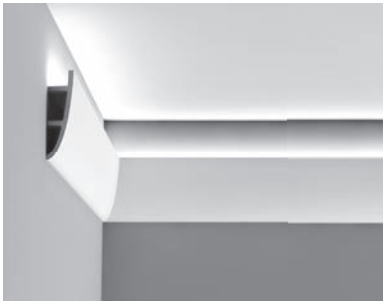
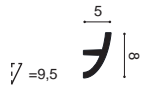

**C374 | C374F ANTONIO** ULF MORITZ

200 x 18 x 5 cm  
 Purotouch<sup>®</sup>  
 Designed by  
 Ulf Moritz

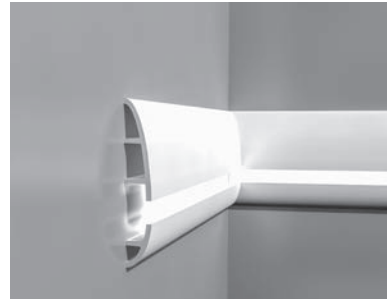
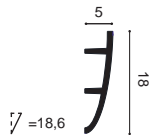

**C374 ANTONIO + C373 ANTONIO**

**Plafond / Ceiling / Decke / Techo**

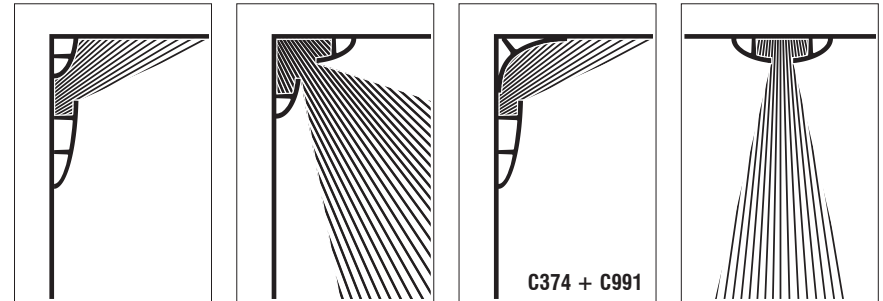

**Muur / Mur / Wall / Wand / Pared**

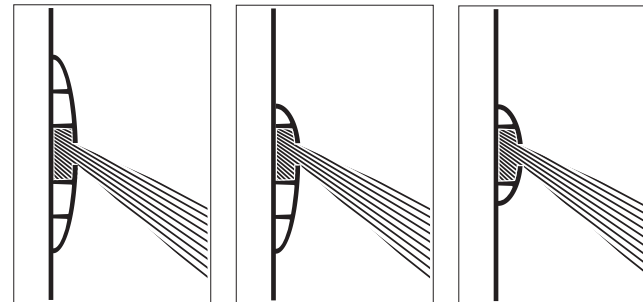

**Vloer / Sol / Floor / Boden / Suelo**

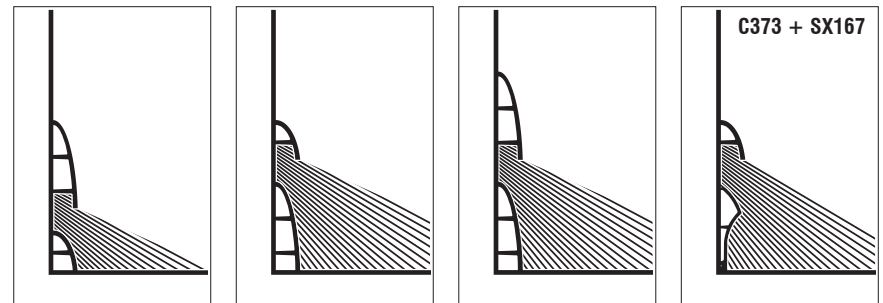

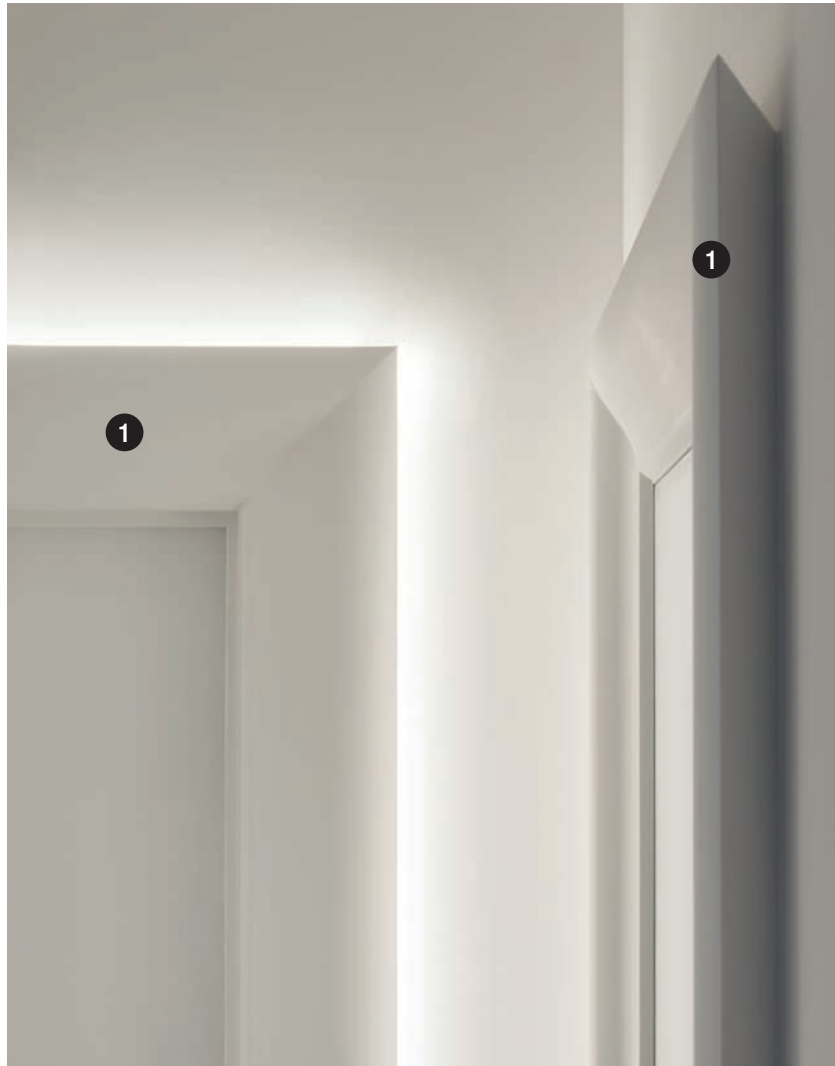

- ❶ C371 SHADE *p. 125*
- ❷ C374 ANTONIO *p. 123*
- ❸ C373 ANTONIO *p. 123*



**C991**

ULF MORITZ

200 x 11 x 14 cm  
 Purotouch®  
 Designed by  
 Ulf Moritz

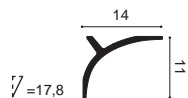

**C900**

LUXXUS

200 x 17,1 x 14,6 cm  
 Purotouch®

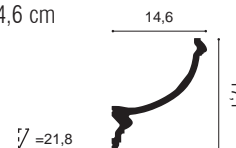

**C901**

LUXXUS

200 x 14,8 x 12,4 cm  
 Purotouch®

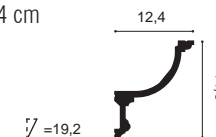

**C371 SHADE**

ULF MORITZ

200 x 18,5 x 5,8 cm  
 Purotouch®  
 Designed by  
 Ulf Moritz

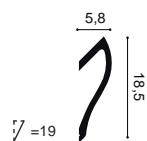

**C372 FLUXUS**

ULF MORITZ

200 x 28 x 7 cm  
 Purotouch®  
 Designed by  
 Ulf Moritz

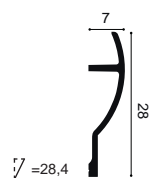

**C902**

LUXXUS

200 x 10,3 x 10,3 cm  
 Purotouch®

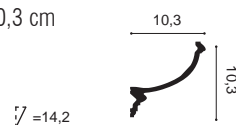

**LIGHTING TIPS !**

**LED**  
 INFO: P120  
 INSTALLATION: P121



## nl

Laat je verbeelding spreken. Ingetogen en waardig in een klassiek interieur, strak en modern in een hedendaagse woning of liever een eclectisch 3D-resultaat? De eindeloze toepassingen met deze ornamenten maken elke ruimte uniek.

## fr

Donnez libre cours à votre imagination. Sobres et dignes dans un intérieur classique, contemporains dans une habitation moderne ou plutôt un résultat 3D éclectique ? Ces ornements aux applications infinies rendent chaque pièce unique.

## en

Follow your imagination. Understated and dignified classic interiors, can be created with our Deco elements. The sleek, modern designs suit contemporary homes, by adding a dramatic 3D form? The elements of these ornaments allow considerable opportunities to personalize any room.

## de

Lassen Sie Ihrer Fantasie freien Lauf. Stilvoll und puristisch in einer klassischen Einrichtung, geradlinig und zeitgenössisch in einer modernen Wohnung oder lieber eine ausgefallene 3D-Gestaltung? Dank der unzähligen Anwendungsmöglichkeiten dieser Ornamente lässt sich jeder Raum einzigartig gestalten.

## es

Escuche a su imaginación. ¿Está buscando un resultado sobrio y señorial para un interior clásico, un acabado elegante y moderno para una casa contemporánea o un efecto ecléctico en 3D? El potencial ilimitado de estos ornamentos consigue que cada habitación sea única.



Decoratieve Elementen  
Eléments Décoratifs  
Deco Elements  
Zierelemente  
Elementos de Decoración



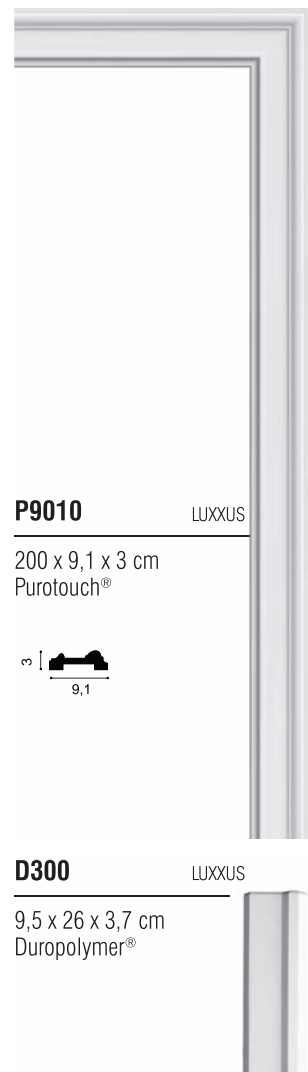

**P9010** LUXXUS

200 x 9,1 x 3 cm  
Purotouch<sup>®</sup>



NEW

**DX170-2300** LUXXUS

230 x 11,9 x 3,2 cm  
Duropolymer<sup>®</sup>



NEW

**D330LR** LUXXUS

12,6 x 16 x 4,1 cm  
Duropolymer<sup>®</sup>



**D210** LUXXUS

9,6 x 9,6 x 3,5 cm  
Duropolymer<sup>®</sup>

**DX121-2300** LUXXUS

230 x 9,4 x 2,3 cm  
Duropolymer<sup>®</sup>



**D310** LUXXUS

9,5 x 24,9 x 3,1 cm  
Duropolymer<sup>®</sup>

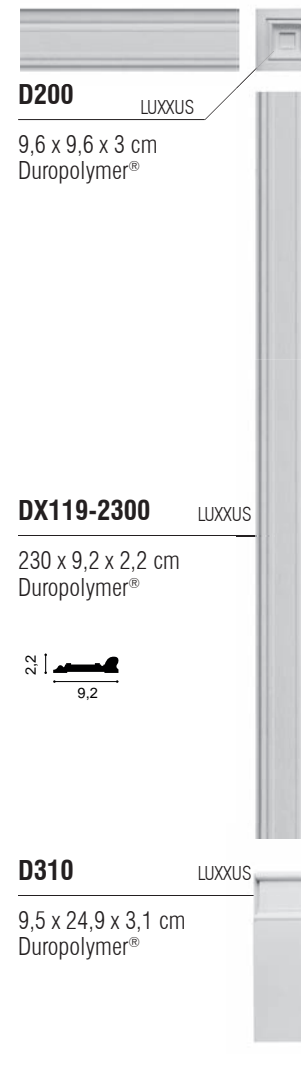

**D200** LUXXUS

9,6 x 9,6 x 3 cm  
Duropolymer<sup>®</sup>

**DX119-2300** LUXXUS

230 x 9,2 x 2,2 cm  
Duropolymer<sup>®</sup>

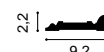

**D310** LUXXUS

9,5 x 24,9 x 3,1 cm  
Duropolymer<sup>®</sup>



**KIT KX001**

1 x DX119, L 107cm  
2 x DX119, L 213 cm  
2 x D200

**KIT KX003**

1 x DX119, L 107cm  
2 x DX119, L 190 cm  
2 x D200  
2 x D310

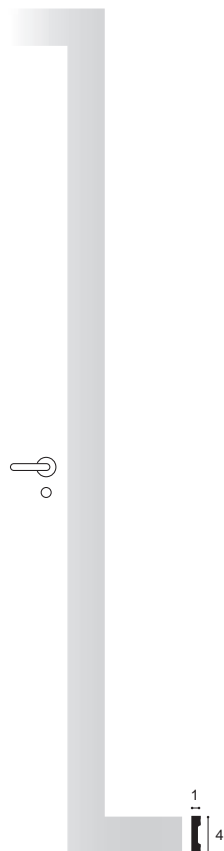

**DX162-2300**

AXXENT

230 x 4 x 1 cm  
Duropolymer<sup>®</sup>

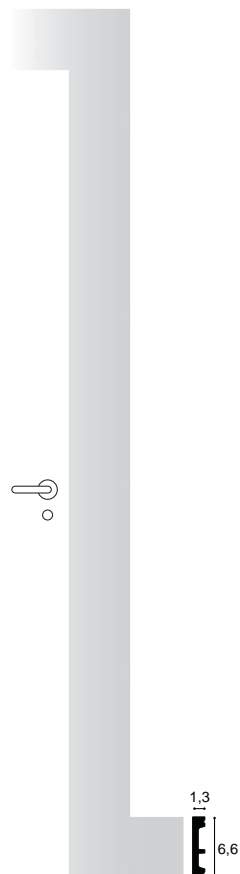

**DX157-2300**

AXXENT

230 x 6,6 x 1,3 cm  
Duropolymer<sup>®</sup>

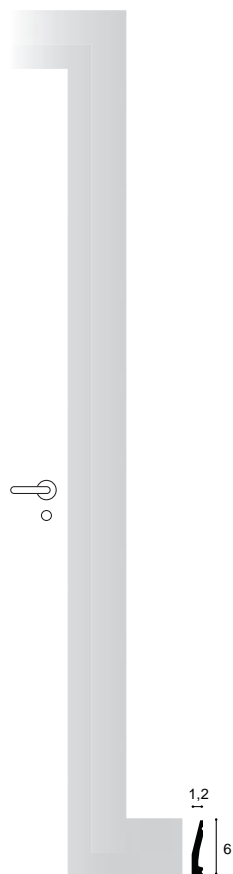

**DX159-2300**

AXXENT

230 x 6 x 1,2 cm  
Duropolymer<sup>®</sup>

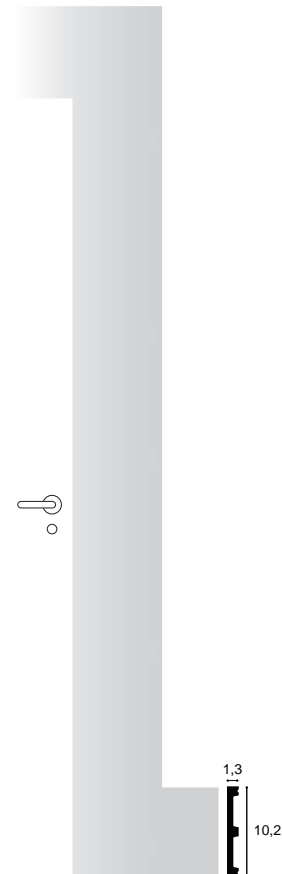

**DX163-2300**

AXXENT

230 x 10,2 x 1,3 cm  
Duropolymer<sup>®</sup>

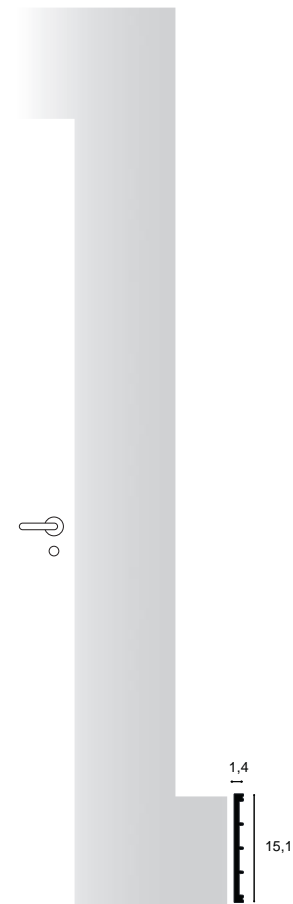

**DX168-2300**

AXXENT

230 x 15,1 x 1,4 cm  
Duropolymer<sup>®</sup>





**D504**

LUXXUS

55 x 22 x 1,7 cm  
Duropolymer<sup>®</sup>



**F30**

LUXXUS

59,5 x 59,5 x 4,3 cm  
Purotouch<sup>®</sup>

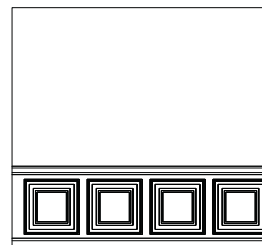

P9010  
F30  
SX118

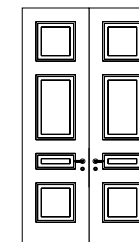

D503  
D507  
D504  
D503

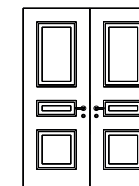

D507  
D504  
D503



**D500**

LUXXUS

55 x 74,7 x 1,6 cm  
Duropolymer<sup>®</sup>

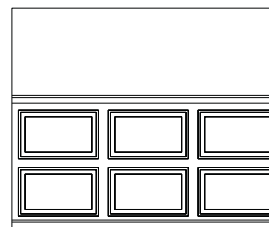

P8050  
D507  
SX156

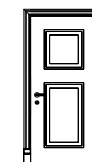

DX121-2300 + D310  
D503  
D507

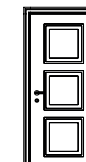

DX119-2300  
3x D503



**D503**

LUXXUS

55 x 55 x 1,7 cm  
Duropolymer<sup>®</sup>



**D507**

LUXXUS

55 x 90,5 x 1,7 cm  
Duropolymer<sup>®</sup>



**D506**

LUXXUS

43 x 43 x 1,7 cm  
Duropolymer<sup>®</sup>

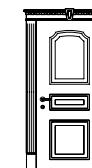

D401 + D402  
2x K200 + D320  
D500  
D504  
D507  
D503

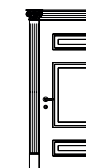

K201L + K200 + K201R  
2x K200  
D504  
D507  
D504  
D320

Lambrisering / Lambris /  
Wainscoting / Wandvertäfelung / Panel de Pared



**PX147**

AXXENT

200 x 16,9 x 0,9 cm  
Duropolymer<sup>®</sup>

**A**

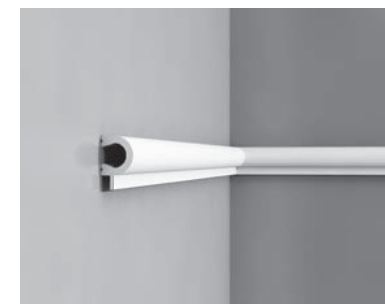

**PX169**

AXXENT

200 x 5,5 x 3,4 cm  
Duropolymer<sup>®</sup>

**B**



**PX147 + PX169**

**A + B**

Frontons / Frontons /  
Pediments / Pedimente / Frontales



**D140** LUXXUS  
98,5 x 31,5 x 2,5 cm  
Purotouch<sup>®</sup>



**D120** LUXXUS  
124 x 25 x 9 cm  
Purotouch<sup>®</sup>



**D402** LUXXUS  
15 x 12,1 x 5,8 cm  
Purotouch<sup>®</sup>  
(only for D400 and D401)



**D161** LUXXUS  
92 x 23 x 3,7 cm  
Purotouch<sup>®</sup>



**D400** LUXXUS  
127,5 x 14,5 x 5,5 cm  
Purotouch<sup>®</sup>



**D400 + D402**



**D170** LUXXUS  
105 x 24,5 x 3,2 cm  
Purotouch<sup>®</sup>



**D401** LUXXUS  
127,5 x 14,5 x 5,5 cm  
Purotouch<sup>®</sup>



**2 x D401 + D402**

# Sierschouwen / Cheminées Décoratives / Decorative Mantel Pieces / Dekorative Kamine / Chimeneas Decorativas

# Nissen / Niches / Niches / Nischen / Hornacinas

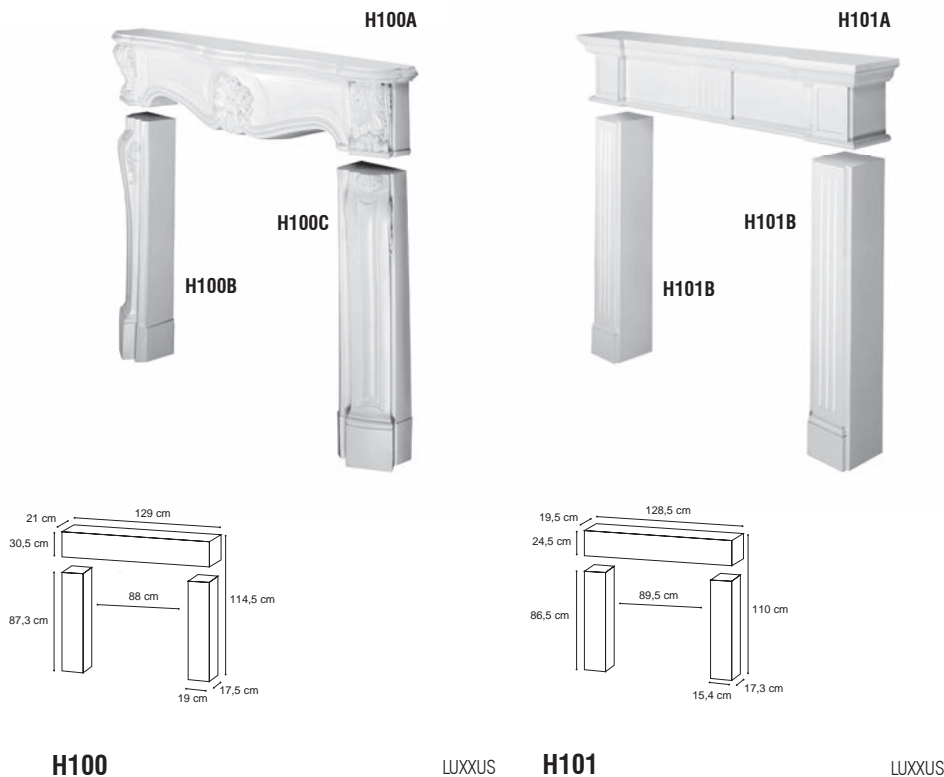

**H100**

LUXXUS

114,5 x 129 x 21 cm  
Purotouch®

**H101**

LUXXUS

110 x 128,5 x 19,5 cm  
Purotouch®

**N503**

1 LUXXUS

69,5 x 113,5 x 11,1 cm  
Purotouch®

**N504**

2 LUXXUS

69,5 x 114 x 10,9 cm  
Purotouch®

**N510**

3 LUXXUS

55,3 x 98,5 x 18 cm  
Purotouch®

**N520**

4 LUXXUS

55,5 x 98,5 x 18 cm  
Purotouch®



(cm)	A	B	C	AA
N503	69,5	113,5	11,1	51,5
N504	69,5	114,0	10,9	49,5

(cm)	F	G	H	FF	GG
N510	55,3	98,5	18,0	53,0	96,0
N520	55,5	98,5	18,0	53,0	92,0

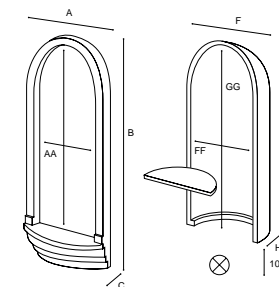

Plaats de gloeilamp (max. 60W) op min. 10cm afstand van de opale bodem.  
Installez l'ampoule (max. 60W) à 10cm minimum du fond opaque.  
Place the bulb (max. 60W) at least 10cm of soil opal.  
Legen Sie die Glühbirne (max. 60W) mindestens 10 cm des Bodens Opal.  
Instale la lámpara (max. 60W) como mínimo a 10 cms del fondo translúcido.



max. 2 à 3 kW

De sierschouwen zijn enkel als decoratief element bedoeld en mogen uitsluitend geplaatst worden in combinatie met een elektrisch vuurtje van max. 2 à 3 kW.  
Les cheminées sont des éléments décoratifs. Elles peuvent seulement être employées avec un feu électrique de max. 2 à 3 kW.  
The fireplaces are just as decorative purposes and should only be installed in conjunction with an electric heater up to 2 to 3 kW.  
Die Kamine sind nur für dekorative Zwecke und sollten nur in Verbindung mit einer elektrischen Heizung bis zu 2 bis 3 kW installiert werden.  
Las chimeneas solamente deben utilizarse como elemento decorativo. Se puede instalar un fuego eléctrico de potencia max. 2-3 Kw.

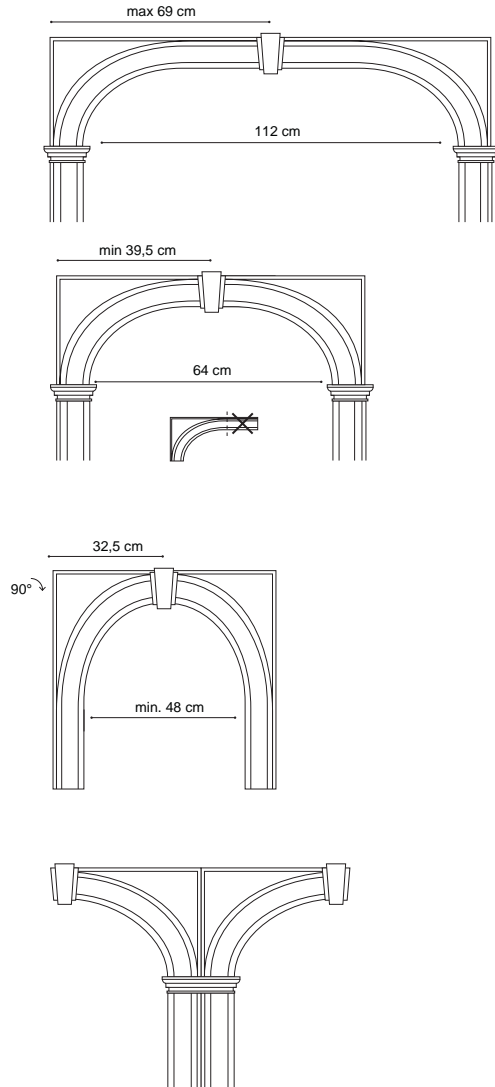

**M9010LR**

64,2 x 32 x 3 cm  
Duropolymer<sup>®</sup>

**M9010R**

LUXXUS

**M9010L**

**M9010A**

**M9010R**

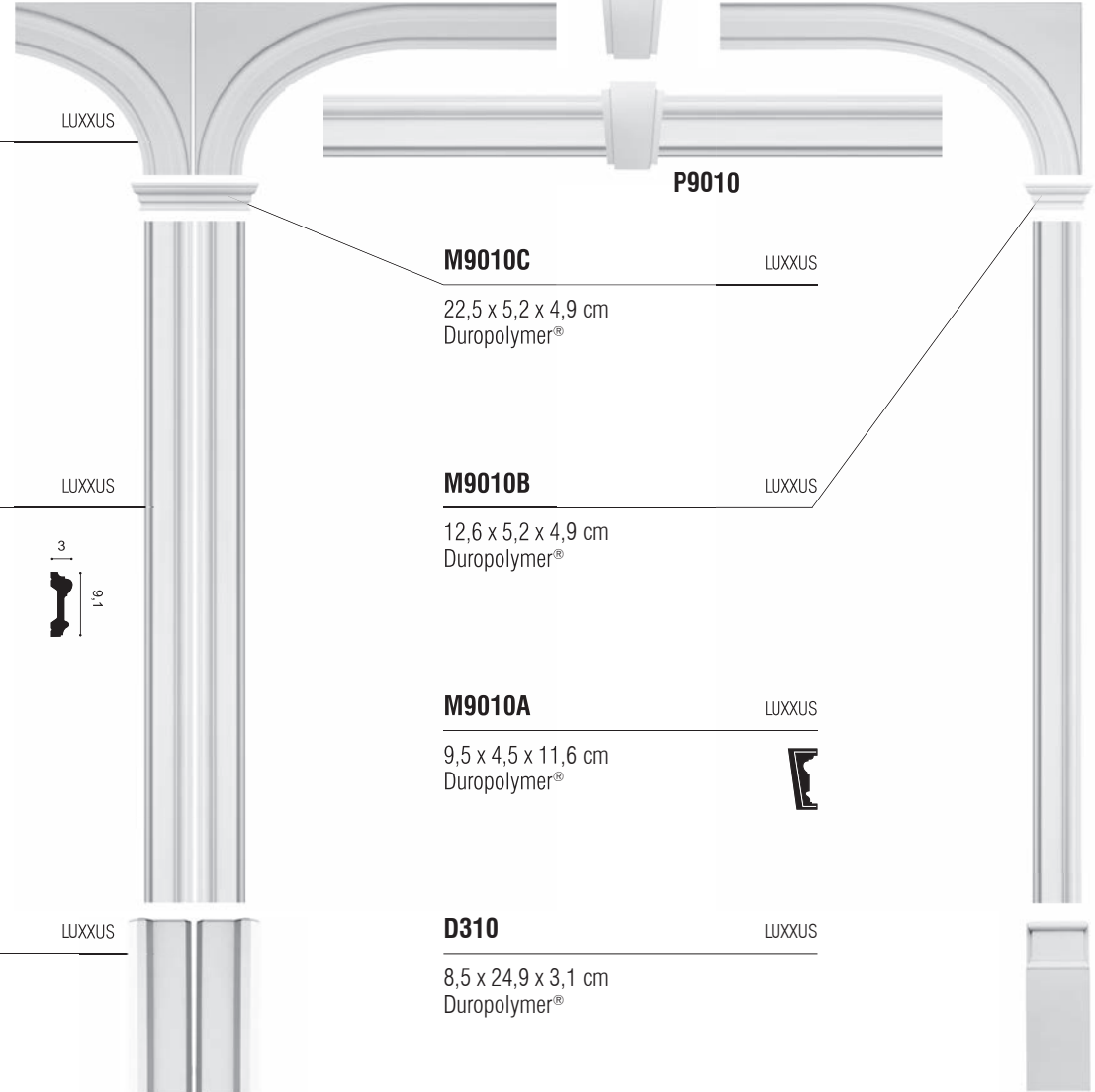

**P9010**

200 x 9,1 x 3 cm  
Purotouch<sup>®</sup>

LUXXUS



**M9010C**

22,5 x 5,2 x 4,9 cm  
Duropolymer<sup>®</sup>

LUXXUS

**M9010B**

12,6 x 5,2 x 4,9 cm  
Duropolymer<sup>®</sup>

LUXXUS

**M9010A**

9,5 x 4,5 x 11,6 cm  
Duropolymer<sup>®</sup>

LUXXUS



**D300**

9,5 x 26 x 3,7 cm  
Duropolymer<sup>®</sup>

LUXXUS

**D310**

8,5 x 24,9 x 3,1 cm  
Duropolymer<sup>®</sup>

LUXXUS



# Byblos

# Wandverlichting / Appliques / Fixtures / Armaturen / Apliques para la Pared



M9010L, M9010A, M9010R  
D200, P9010, D300, D503, D504, SX118

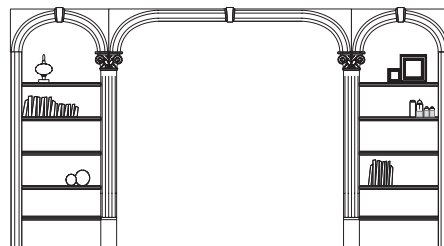

M9010L, M9010A, M9010R  
K200, K201, D320

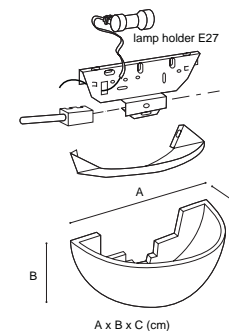

**L504**

LUXXUS

30,5 x 15,3 x 15 cm  
Duropolymer®

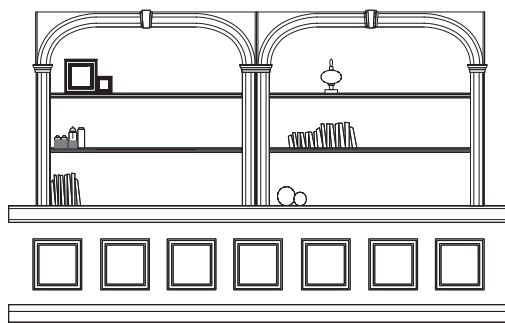

M9010L, M9010A, M9010R, M9010B, M9010C  
P9010, P9020, D506, SX105

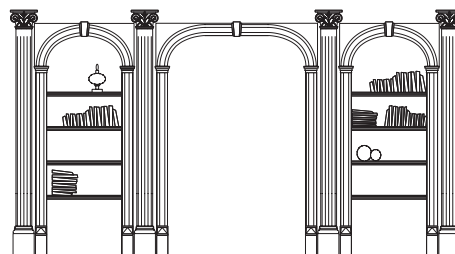

M9010L, M9010A, M9010R, M9010B  
K201, K200, K202, P9010, D310



**L505**

LUXXUS

40,8 x 11,5 x 16,3 cm  
Duropolymer®

Rozetten / Rosaces /  
Ceiling Roses / Rosetten / Rosetones

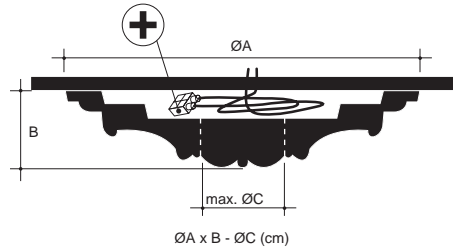

**D62** LUXXUS

15,6 x 11,6 x 1,4 cm  
Purotouch<sup>®</sup>

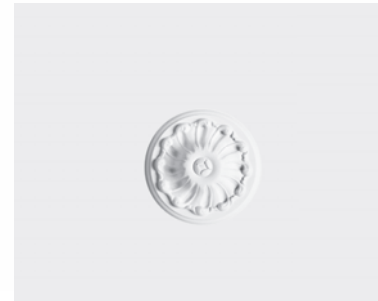

**R10** LUXXUS

ø 15 x 4,2 - ø 2 cm  
Purotouch<sup>®</sup>



**R11** LUXXUS

ø 19 x 3,6 - ø 3 cm  
Purotouch<sup>®</sup>

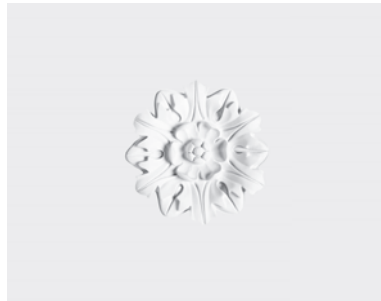

**R12** LUXXUS

ø 19,5 x 1,8 - ø 1 cm  
Purotouch<sup>®</sup>



**R35** LUXXUS

ø 20,5 x 2,7 cm  
Purotouch<sup>®</sup>

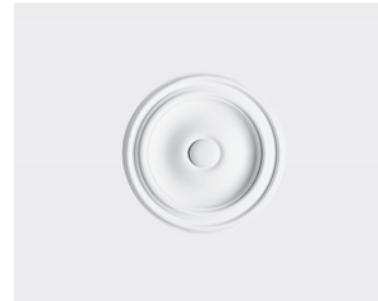

**R07** LUXXUS

ø 26 x 3 - ø 5 cm  
Purotouch<sup>®</sup>

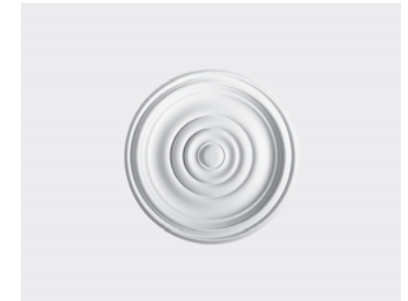

**R08** LUXXUS

ø 38 x 4,2 - ø 5 cm  
Purotouch<sup>®</sup>

Rozetten / Rosaces /  
Ceiling Roses / Rosetten / Rosetones



**R13** LUXXUS

ø 28 x 3,1 - ø 2,5 cm  
Purotouch<sup>®</sup>



**R50** LUXXUS

ø 32 x 3,8 - ø 19 cm  
Purotouch<sup>®</sup>



**R14** LUXXUS

ø 33 x 3 - ø 2,5 cm  
Purotouch<sup>®</sup>



**R31** LUXXUS

ø 38,5 x 2,7 - ø 3,5 cm  
Purotouch<sup>®</sup>



**R61** LUXXUS

ø 40 x 3,1 - ø 2,5 cm  
Purotouch<sup>®</sup>



**R17** LUXXUS

ø 47 x 3,5 - ø 6,5 cm  
Purotouch<sup>®</sup>

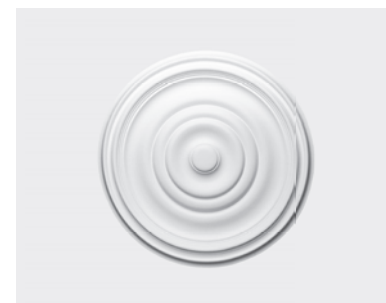

**R09** LUXXUS

ø 48,5 x 3,7 - ø 6 cm  
Purotouch<sup>®</sup>



**R18** LUXXUS

ø 49 x 4,7 - ø 7 cm  
Purotouch<sup>®</sup>

Rozetten / Rosaces /  
Ceiling Roses / Rosetten / Rosetones



**R46** LUXXUS

ø 53,5 x 4,2 - ø 3 cm  
Purotouch<sup>®</sup>



**R66** LUXXUS

ø 54,5 / 43 x 2,4 cm  
Purotouch<sup>®</sup>

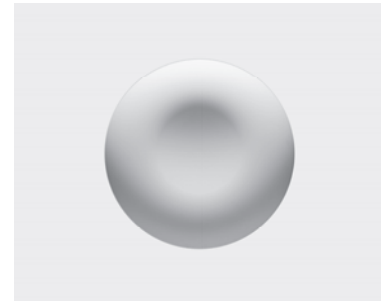

**R70** ULF MORITZ

ø 60 x 7,7 cm  
Purotouch<sup>®</sup>

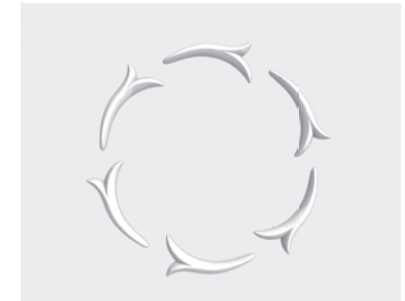

**6x G77 LILY** ULF MORITZ

19,4 x 8,8 x 1,8 cm  
Duropolymer<sup>®</sup>



**R76** LUXXUS

ø 62 x 4,1 - ø 10,5 cm  
Purotouch<sup>®</sup>



**R77** LUXXUS

ø 62 x 4,2 - ø 10,5 cm  
Purotouch<sup>®</sup>

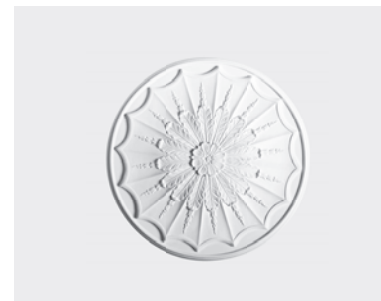

**R28** LUXXUS

ø 68,5 x 5,2 - ø 2 cm  
Purotouch<sup>®</sup>

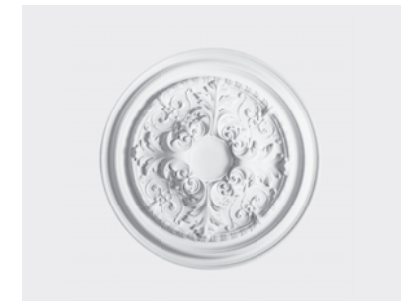

**R52** LUXXUS

ø 69,5 x 4,8 - ø 12,5 cm  
Purotouch<sup>®</sup>



Rozetten / Rosaces /  
Ceiling Roses / Rosetten / Rosetones



**R73** LUXXUS

ø 70 x 5,9 - ø 8 cm  
Purotouch<sup>®</sup>



**R38** LUXXUS

ø 71 x 4,2 - ø 19 cm  
Purotouch<sup>®</sup>



**R23** LUXXUS

ø 71 x 4,4 - ø 6 cm  
Purotouch<sup>®</sup>



**R40** LUXXUS

ø 74,5 x 3,1 - ø 10 cm  
Purotouch<sup>®</sup>



**R27** LUXXUS

ø 75 x 4,5 - ø 9 cm  
Purotouch<sup>®</sup>



**R22** LUXXUS

77,5 x 53 x 3,6 cm  
Purotouch<sup>®</sup>



**R24** LUXXUS

ø 79 x 6 - ø 8 cm  
Purotouch<sup>®</sup>



**R64** LUXXUS

ø 95,2 x 4,8 - ø 7 cm  
Purotouch<sup>®</sup>





**F30** LUXXUS

59,5 x 59,5 x 4,3 cm  
Purotouch<sup>®</sup>

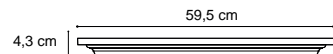

**F31** LUXXUS

59,5 x 59,5 x 6,6 cm  
Purotouch<sup>®</sup>

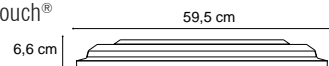

**F12** LUXXUS

34 x max. diam. 133,5 cm  
Purotouch<sup>®</sup>

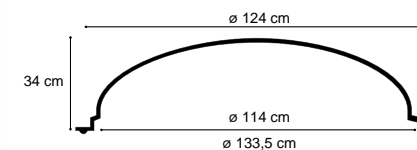

**F10** LUXXUS

11,2 x max. diam. 90 cm  
Purotouch<sup>®</sup>

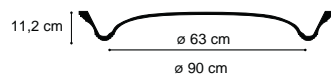

**F11** LUXXUS

9,5 x max. diam. 74,5 cm  
Purotouch<sup>®</sup>

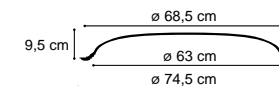



**G40** LUXXUS

16,4 x 13,4 x 1,5 cm  
Duropolymer<sup>®</sup>



**D200** LUXXUS

9,6 x 9,6 x 3 cm  
Duropolymer<sup>®</sup>

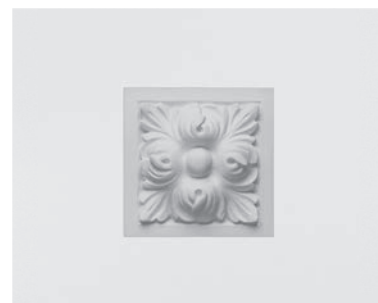

**D210** LUXXUS

9,6 x 9,6 x 3,5 cm  
Duropolymer<sup>®</sup>



**P5020B** LUXXUS

9 x 9 x 1,3 cm  
Purotouch<sup>®</sup>



**G42** LUXXUS

39,8 x 4,4 x 1,9 cm  
Duropolymer<sup>®</sup>



**P21** LUXXUS

6,7 x 6,7 x 0,9 cm  
Duropolymer<sup>®</sup>

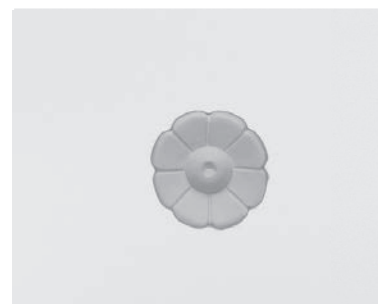

**P20** LUXXUS

Ø 6,1 - 0,8 cm  
Duropolymer<sup>®</sup>



**D62** LUXXUS

15,6 x 11,6 x 1,4 cm  
Purotouch<sup>®</sup>



**G70 FOLIO**

ULF MORITZ

20 x 9 x 2,7 cm  
Duropolymer<sup>®</sup>

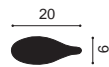

**G72 SMILE**

ULF MORITZ

42,5 x 6,8 x 1 cm  
Duropolymer<sup>®</sup>

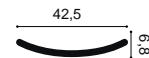

NEW

**G78 LILY**

ULF MORITZ

8,8 x 4,4 x 1,9 cm  
Duropolymer<sup>®</sup>



NEW

**G77 LILY**

ULF MORITZ

19,4 x 8,8 x 1,8 cm  
Duropolymer<sup>®</sup>



**G73L CURL MINI**

ULF MORITZ

20,1 x 18,1 x 1 cm  
Purotouch<sup>®</sup>



**G73R CURL MINI**

ULF MORITZ

20,1 x 18,1 x 1 cm  
Purotouch<sup>®</sup>

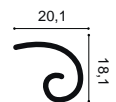

**G74L CURL MAXI**

ULF MORITZ

25,4 x 24,4 x 1,1 cm  
Purotouch<sup>®</sup>

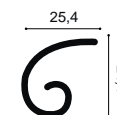

**G74R CURL MAXI**

ULF MORITZ

25,4 x 24,4 x 1,1 cm  
Purotouch<sup>®</sup>

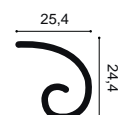



Decoratieve Elementen / Éléments décoratifs / Deco Elements  
Zierelemente / Elementos de Décoración



**G71 SCALA**

ULF MORITZ

42,2 x 35 x 1,5 cm  
Purotouch®

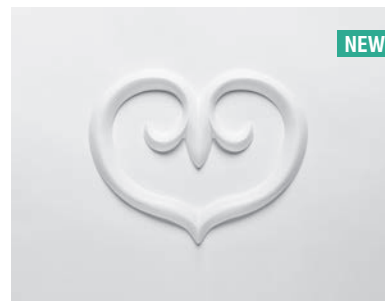
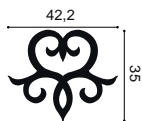

**G75 SCALA**

ULF MORITZ

27 x 21 x 1,4 cm  
Purotouch®



**G76 SCALA**

ULF MORITZ

8 x 17,8 x 1,5 cm  
Purotouch®



Gesegmenteerde Zuilen / Colonne Segmentées  
Segmented Columns / Säulensegmente  
Columnas Segmentados

**K4132** (H 21,5 cm)



**5 x K4002** (H 72 cm)

**4 x K4002** (H 72 cm)

**3 x K4002** (H 72 cm)

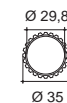

K4132 + 3x(K4002 + K4122) = 274 cm H max  
K4132 + 4x(K4002 + K4122) = 345 cm H max  
K4132 + 5x(K4002 + K4122) = 416 cm H max

**K4122** (H 40cm)

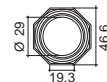

**K4131** (H 21,5 cm)



**5 x K4001** (H 72 cm)

**4 x K4001** (H 72 cm)

**3 x K4001** (H 72 cm)



K4131 + 3x(K4001 + K4121) = 274 cm H max  
K4131 + 4x(K4001 + K4121) = 345 cm H max  
K4131 + 5x(K4001 + K4121) = 416 cm H max

**K4121** (H 40cm)



# Volle Zuilen / Colonnas Entières / Full Columns

## Vollsäulen / Columnas Completas

**K1142** (H 16 cm)



**K1142** (H 16 cm)



**K1112** (H 30 cm)



**K1112** (H 30 cm)



**K1122** (H 30 cm)



**K1122** (H 30 cm)



**K1002** (H 199,5 cm)



**K1102** (H 202 cm)



**K3142** (H 20 cm)



**K3142** (H 20 cm)



**K3142** (H 20 cm)



**K3112** (H 12,5 cm)



**K3112** (H 12,5 cm)



**K3112** (H 12,5 cm)

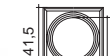

**K3002** (H 201 cm)

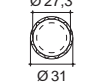

**K3102** (H 202 cm)

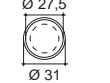

**K3202** (H 241,5 cm)

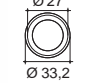

K1142 + K1002 + K1152 = 225 cm H  
 K1142 + K1002 + K1132 = 270 cm H max  
 K1112 + K1002 + K1152 = 242 cm H  
 K1112 + K1002 + K1132 = 287 cm H max  
 K1122 + K1002 + K1152 = 242 cm H  
 K1122 + K1002 + K1132 = 287 cm H max

K1142 + K1102 + K1152 = 227,5 cm H  
 K1142 + K1102 + K1132 = 272,5 cm H max  
 K1112 + K1102 + K1152 = 244,5 cm H  
 K1112 + K1102 + K1132 = max: 289,5 cm H max  
 K1122 + K1102 + K1152 = 244,5 cm H  
 K1122 + K1102 + K1132 = 289,5 cm H max

K3142 + K3002 + K2132 = 237 cm H  
 K3142 + K3002 + K3152 = 275 cm H max  
 K3112 + K3002 + K2132 = 233,5 cm H  
 K3112 + K3002 + K3152 = 271,5 cm H max

K3142 + K3102 + K2132 = 237 cm H  
 K3142 + K3102 + K3152 = 275 cm H max  
 K3112 + K3102 + K2132 = 233,5 cm H  
 K3112 + K3102 + K3152 = 271,5 cm H max

K3142 + K3202 + K2132 = 277,5 cm H  
 K3142 + K3202 + K3152 = 315,5 cm H max  
 K3112 + K3202 + K2132 = 274 cm H  
 K3112 + K3202 + K3152 = 312 cm H max

**K1152** (H 12,5 cm)

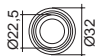

**K1152** (H 12,5 cm)

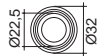

**K1132** (H 57,5 cm)



**K1132** (H 57,5 cm)



**K2132** (H 20 cm)



**K2132** (H 20 cm)



**K2132** (H 20 cm)



**K3152** (H 58 cm)



**K3152** (H 58 cm)



**K3152** (H 58 cm)



# Halve Zuilen / Demi-Colonnes / Half Columns Halbsäulen / Medias Columnas

**K1141** (H 16 cm)



**K1111** (H 30cm)



**K1121** (H 30 cm)



**K1001** (H 199,5 cm)



K1141 + K1001 + K1151 = 225 cm H  
K1141 + K1001 + K1131 = 270 cm H max  
K1111 + K1001 + K1151 = 242 cm H  
K1111 + K1001 + K1131 = 287 cm H max  
K1121 + K1001 + K1151 = 242 cm H  
K1121 + K1001 + K1131 = 287 cm H max

**K1141** (H 16 cm)



**K1111** (H 30 cm)



**K1121** (H 30 cm)



**K1101** (H 202 cm)



K1141 + K1101 + K1151 = 227,5 cm H  
K1141 + K1101 + K1131 = 272,5 cm H max  
K1111 + K1101 + K1151 = 244,5 cm H  
K1111 + K1101 + K1131 = max. 289,5 cm H max  
K1121 + K1101 + K1151 = 244,5 cm H  
K1121 + K1101 + K1131 = 289,5 cm H max

**K3141** (H 20 cm)



**K3111** (H 12,5 cm)



**K3001** (H 201 cm)



K3141 + K3001 + K2131 = 237 cm H  
K3141 + K3001 + K3151 = 276 cm H max  
K3111 + K3001 + K2131 = 233,5 cm H  
K3111 + K3001 + K3151 = 271,5 cm H max

**K3141** (H 20 cm)



**K3111** (H 12,5 cm)



**K3101** (H 202 cm)



K3141 + K3101 + K2131 = 237 cm H  
K3141 + K3101 + K3151 = 276 cm H max  
K3111 + K3101 + K2131 = 233,5 cm H  
K3111 + K3101 + K3151 = 271,5 cm H max

**K3141** (H 20 cm)



**K3111** (H 12,5 cm)



**K3201** (H 241,5 cm)



K3141 + K3201 + K2131 = 277,5 cm H  
K3141 + K3201 + K3151 = 316,5 cm H max  
K3111 + K3201 + K2131 = 274 cm H  
K3111 + K3201 + K3151 = 312 cm H max

**K1151** (H 12,5 cm)



**K1131** (H 57,5 cm)



**K1151** (H 12,5 cm)



**K1131** (H 57,5 cm)



**K2131** (H 20 cm)



**K3151** (H 58 cm)



**K2131** (H 20 cm)



**K3151** (H 58 cm)



**K2131** (H 20 cm)



**K3151** (H 58 cm)



Pilasters / Pilastres / Pilasters  
Pilaster / Pilastras

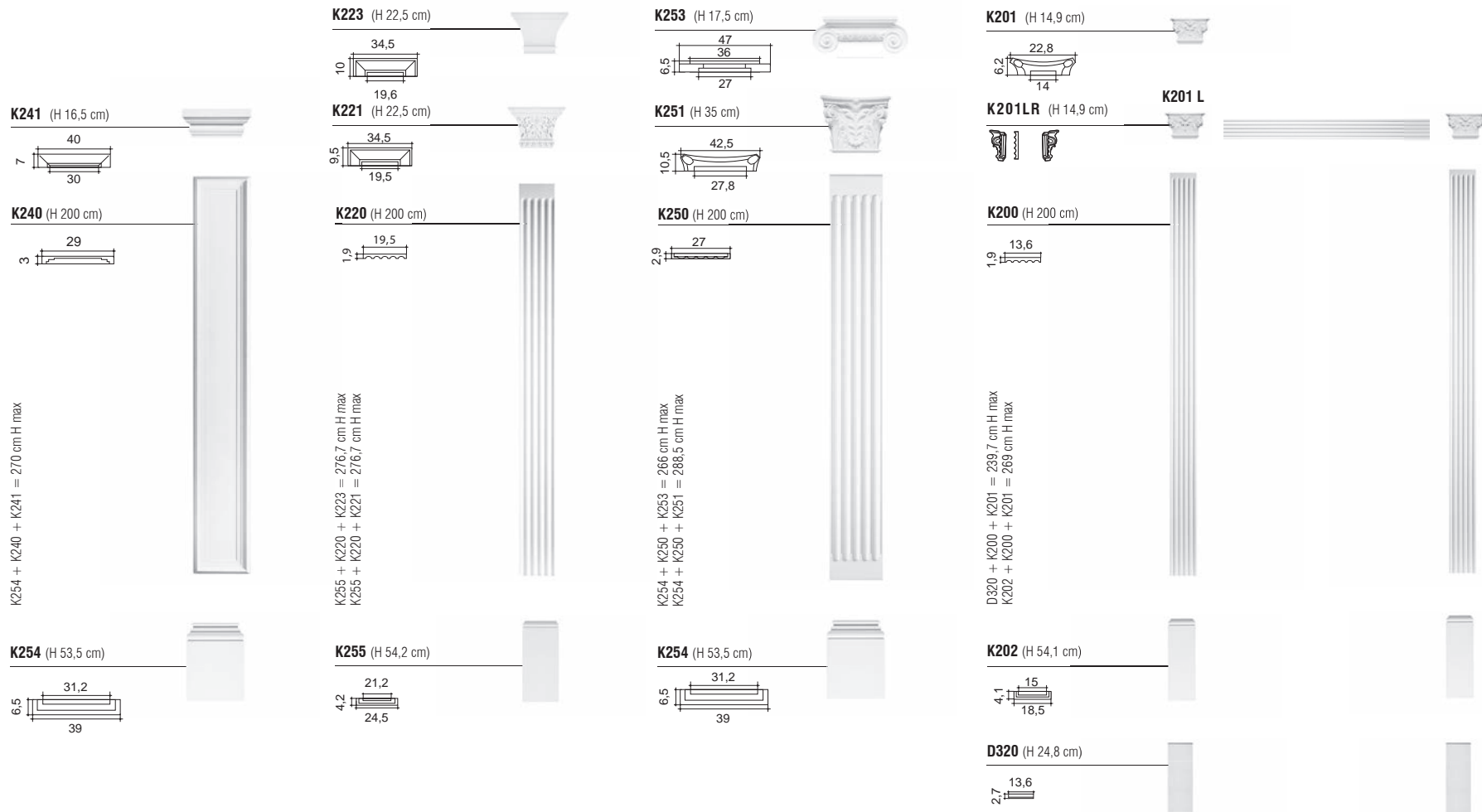

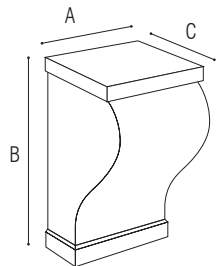

A x B x C (cm)



**B401** LXXXUS

11,6 x 15,4 x 7 cm  
Purotouch<sup>®</sup>



**B404** LXXXUS

19,3 x 31,5 x 11,3 cm  
Purotouch<sup>®</sup>



**B408** LXXXUS

21,5 x 39 x 12,6 cm  
Purotouch<sup>®</sup>



**B409** LXXXUS

30 x 35 x 17,5 cm  
Purotouch<sup>®</sup>



**B410** LXXXUS

19,3 x 49 x 15,8 cm  
Purotouch<sup>®</sup>



**B413** LXXXUS

16,5 x 22,7 x 8,5 cm  
Purotouch<sup>®</sup>



**B414** LXXXUS

10,1 x 22,5 x 7,2 cm  
Purotouch<sup>®</sup>



**B417** LXXXUS

90,6 x 12,5 x 14 cm  
Purotouch<sup>®</sup>



**GB02** LXXXUS

7 x 40 x 49 cm  
Duropolymer<sup>®</sup>



**GB03** LXXXUS

7 x 63 x 58 cm  
Duropolymer<sup>®</sup>



**GB04** LXXXUS

5 x 74,5 x 77 cm  
Duropolymer<sup>®</sup>



**TF02** LXXXUS

7,7 x 12 x 10,5 cm  
Duropolymer<sup>®</sup>



GB02 - GB03 - GB04 - TF02





Lijmen en Toebehoren  
Colles et Accessoires  
Adhesives and Accesories  
Kleber und Zubehör  
Adhesivo y Accesorios



## DecoFix Pro



FDP500 310ml  
> 7 - 8m  
FDP600 4200ml  
> 65 - 110m

## DecoFix Hydro



FDP700 290ml  
> 7 - 8 m

## DecoFix Extra



FX200 310ml  
> 80m  
FX210 80ml  
> 20m

nl

**Extra sterke installatielijm voor poreuze ondergrond en binnentoepassingen**

- Sterke acrylijm op waterbasis
- Langdurende verbinding tussen profielen en muur en/of plafond
- Verwijder met een vochtige spons of doek
- Vorstvrij bewaren
- Overschilderbaar na uitharding (min. 24u)

**Extra sterke MS-polymeerlijm voor buitengebruik, op niet-poreuze (tegels, glas,...) ondergrond en in vochtige ruimtes**

- Verwijder met een zeepoplossing
- Overschilderbaar na uitharding (min. 24u)

**Lijm op polyurethaanbasis voor naadverbindingen tussen profielen**

- Verwijder de overtollige lijm vóór uitharding (herhaal na max. 1 uur en na 2 tot 3 uur)
- Maak schoon met aceton of synthetische verdunner
- Overschilderbaar na 24 uur
- Hoe hoger de vochtigheidsgraad, hoe sneller de droogtijd

fr

**Colle d'installation ultra forte pour surfaces poreuses et applications intérieures**

- Colle forte à base d'eau et d'acrylique
- Joint longue durée entre les moulures et le mur et/ou le plafond
- Retirez à l'aide d'une éponge ou d'un chiffon humide
- Doit être conservé à l'abri du gel
- Peut être peinte après séchage (min. 24 heures)

**Colle au MS polymère extra forte pour utilisation extérieure, surfaces non poreuses (carrelage, verre, etc...) et environnements humides**

- Enlevez à l'aide d'une solution savonneuse
- Peut être peinte après séchage (min. 24 heures)

**Colle polyuréthane pour l'assemblage des joints entre les moulures**

- Éliminez les excès de colle avant le durcissement (1 heure max. et recommencez après 2-3 heures)
- Nettoyez avec de l'acétone ou un diluant synthétique
- Peut être peint après 24 h
- Un taux d'humidité plus élevé peut accélérer le temps de séchage

en

**Extra strong installation adhesive for porous surfaces and interior applications**

- Strong, water-based acrylic glue
- Long-lasting seal between mouldings and the wall and/or ceiling
- Remove with humid sponge or cloth
- Should be kept frost free
- Paintable after hardening (min. 24 hours)

**Extra strong MS polymer glue for exterior applications, non-porous (tiles, glass, ...) surfaces and damp environments**

- Remove with soap solution
- Paintable after hardening (min. 24 hours)

**Polyurethane-based glue to seam joints between mouldings**

- Remove excess glue before hardening (max. 1 hour and repeat after 2-3 hours)
- Clean with acetone or Synth Thinner
- Can be painted after 24 hrs
- The more humidity, the faster the drying time

de

**Extra starker Montagekleber auf saugenden Untergründen und für den Innenbereich**

- Starker, wasserbasierter Acrylkleber
- Langhaltende Verbindung zwischen Profilen und Wand und/oder Decke
- Mit wenig feuchtem Schwamm oder Tuch entfernen
- Frostfrei lagern
- Anstrichverträglich nach Aushärtung (min. 24 St.)

**Besonders starker MS-Polymerkleber für den Außenbereich, auf nicht porösem (Fliesen, Glas, ...) Untergrund und in Feuchträumen**

- Mit Seifenlösung entfernen
- Anstrichverträglich nach Aushärtung (min. 24 St.)

**Polyurethanbasierter Kleber für Nahtverbindungen zwischen Profilen**

- Überschüssigen Kleber vor dem Aushärten entfernen (nach 1 Std und nach 2-3 Std wiederholen)
- Mit Aceton oder synthetischem Verdünner reinigen
- Nach 24 Std überstreichbar
- Je höher die Luftfeuchtigkeit, desto kürzer die Trockenzeit

es

**Adhesivo superfuerte para soportes porosos y aplicaciones en el interior**

- Fuerte, cola acrílica con base de agua
- Larga adherencia entre molduras y techos o paredes
- Eliminar con una esponja o paño húmedo
- Debe guardarse en un ambiente seco
- Pintable después de endurecimiento (min. 24 horas)

**Adhesivo MS polímero extra fuerte para aplicaciones al exterior, superficies no porosas (cerámica, vidrio, ...) y lugares húmedos**

- Eliminar con agua y jabón
- Pintable después de endurecimiento (min. 24 horas)

**Adhesivo a base de poliuretano para unir las piezas entre si**

- Eliminar cola excesiva antes de endurecer (max. 1 hora y repetir 2-3 horas después)
- Limpiar con acetona o disolvente sintético
- Puede pintarse después de 24 horas
- Cuanta más humedad, más rápida la duración de secado

**VOLLEDIGE GARANTIE  
ENKEL BIJ GEBRUIK VAN  
DECOFIX**

**GARANTIE TOTALE  
UNIQUEMENT AVEC COLLE  
DECOFIX**

**ONLY FULL  
GUARANTEE WITH  
DECOFIX**

**VOLLSTÄNDIGE GARANTIE  
NUR BEI DER  
VERWENDUNG VON  
DECOFIX**

**GARANTÍA COMPLETA  
SÓLO SI SE UTILIZA  
DECOFIX**





**Binnen, poreuze en droge ondergronden**  
**Pose à l'intérieur, surfaces poreuses, pièces non humides**  
**Interior, porous and dry surface**  
**Innen, poröse/saugfähige und trockene Untergründe**  
**Interior, superficies secas y porosas**



### DecoFix Pro

Lijmen op wanden en plafonds  
 Collage sur mur et plafond  
 Gluing on wall and ceiling  
 Kleben an Wand und Decke  
 Encolar al techo y la pared



### DecoFix Extra

Naden  
 Joints  
 Stoßstellen  
 Uniones entre piezas



Voor Basix: gebruik DecoFix Pro voor de naden  
 Pour Basix: utilisez DecoFix Pro pour les joints  
 For Basix: use DecoFix Pro for joints  
 Für Basix: verwenden Sie DecoFix Pro für die Stoßstellen  
 Para Basix: utilice DecoFix Pro para las uniones entre piezas



**Buiten, niet-poreuze en vochtige ondergronden**  
**Environnement humide, surfaces non poreuses, pose à l'extérieur**  
**Exterior, non-porous and humid surface**  
**Außen, nicht-poröser/saugfähige Untergrund und Feuchträume**  
**Exterior, ambientes húmedos e instalaciones en superficies no porosas**



### DecoFix Hydro

Lijmen op wanden en plafonds  
 Collage sur mur et plafond  
 Gluing on wall and ceiling  
 Kleben an Wand und Decke  
 Encolar al techo y la pared



## Toebehoren / Accessoires / Accesorios / Zubehör / Accesorios



FDP100



FB15

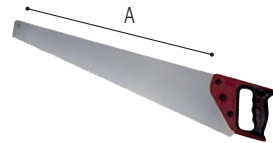

FB14  
 A: 60 cm

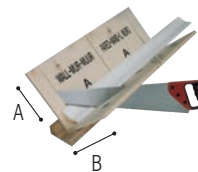

FB300  
 A: 29,7 cm - B: 29,1cm

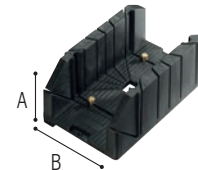

FB13  
 A: 12,5 cm - B: 15,5 cm



FB10  
 A: 27,5 cm - B: 22 cm



**LOW LUMER LED BARS**

**IL004-001** 26 x 2 x 1,5 cm   
**IL004-002** 114,5 x 2 x 1,5 cm

IP50 - 24V  
 warm white 2700-2900K  
 2 clips incl.  
 CRI: 80  
 Light output / meter: +/- 100Lm  
 Power / meter: +/- 4W  
 Life span: +/- 30.000 hours



**HIGH LUMEN LED BARS**

**IL004-006** 26 x 2 x 1,5 cm   
**IL004-007** 114,5 x 2 x 1,5 cm

IP50 - 24V  
 warm white 2700-2900K  
 2 clips incl.  
 CRI: 80  
 Light output / meter: +/- 500Lm  
 Power / meter: +/- 10.5W  
 Life span: +/- 30.000 hours



**LED DRIVER**

**IL004-013** 30,5 x 3 x 1,7 cm

IP20 - 60W  
 24VDC - 200-240VAC  
 Class II (double insulated)



**1-10V DIMMABLE MODULE**

**IL004-009** 16 x 4,7 x 2,2 cm

IP40 - 240W (<10A)  
 12-24VDC

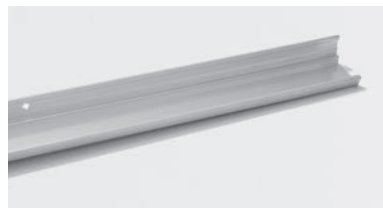

**ALUMINIUM SUPPORT**

**IL004-008**   
 200 x 2 x 3 cm

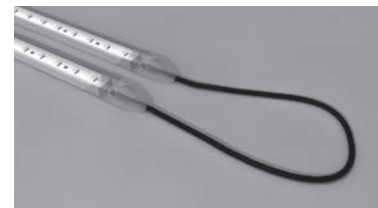

**CABLES TWO CONNECTIONS**

**IL004-004** 12,5 cm  
**IL004-005** 100 cm



**CABLE ONE CONNECTION**

**IL004-010** 100 cm  
 DRIVER > LED BAR

# LED BARS

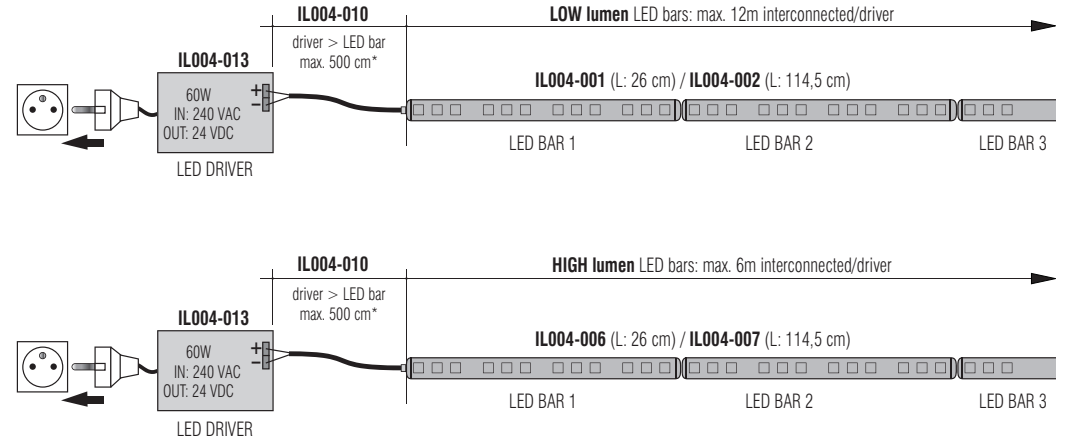

\*max. = 1x IL004-010 + 4x IL004-005

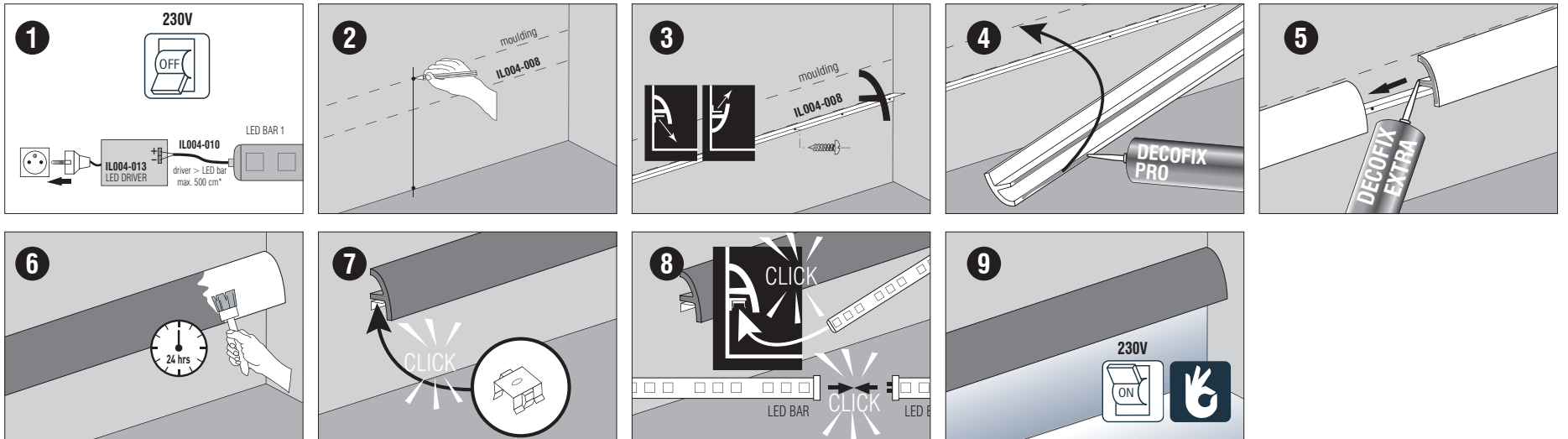



### nl

- Meer dan 40 jaar internationale projectervaring
- Installatietraining mogelijk in ORAC en op locatie
- 2D en 3D-files beschikbaar op [www.oracdecor.com](http://www.oracdecor.com)
- Een wereldwijd netwerk van toegewijde partners
- Makkelijke en vlotte stalenservice
- Professioneel advies van begin tot einde uitvoering

### fr

- Plus de 40 ans d'expérience internationale
- Possibilités de formation à l'installation tant chez ORAC que sur site
- Fichiers 2D et 3D disponibles sur [www.oracdecor.com](http://www.oracdecor.com)
- Des partenaires mondiaux dévoués
- Un service d'échantillonnage simple et efficace
- Des conseils professionnels accompagnant votre projet

### en

- More than 40 years of international expertise
- In house and on site installation training available
- 2D and 3D files available on [www.oracdecor.com](http://www.oracdecor.com)
- Dedicated worldwide partners
- Sample service for professionals
- Technical advice from our in house experts

### de

- Mehr als 40 Jahre internationale Erfahrung
- Installationsschulungen bei ORAC und vor Ort
- 2D- und 3D-Dateien auf [www.oracdecor.com](http://www.oracdecor.com) erhältlich
- Engagierte Partner weltweit
- Einfacher und reibungsloser Musterservice
- Professionelle Hinweise von Anfang bis Ende

### es

- Más de 40 años de experiencia internacional
- Orientaciones personalizadas en instalación de nuestros productos en ORAC e in situ
- Archivos en 2D y en 3D disponibles en [www.oracdecor.com](http://www.oracdecor.com)
- Prescriptores apasionados y comprometidos por todo el mundo
- Un servicio de muestras fácil y fluido
- Asesoramiento profesional desde el principio hasta el final



**nl**

Zowel de Ulf Moritz, Luzzus als Axxent producten zijn geschikt voor buitengebruik.

Installatie-instructies op pg. 150 - 151.

Deze producten dienen met een kwalitatieve buitenverf overschilderd te worden.

**fr**

Les produits Ulf Moritz, Luzzus ainsi que les produits Axxent conviennent pour l'extérieur.

Instructions d'installation, voir pg. 150 - 151.

Ces produits doivent être parachevés avec une peinture spéciale pour extérieur.

**en**

All Ulf Moritz, Luzzus and Axxent products can be used for exterior applications.

Gluing instructions on pg. 150 - 151.

The products have to be painted with a special coating for outside use.

**de**

Alle Produkte von Ulf Moritz, Luzzus und Axxent eignen sich für die Verwendung im Außenbereich.

Klebeanleitung auf Seite 150 - 151.

Die Produkte müssen mit witterungsbeständigen Fassadenfarben oder Lacken beschichtet werden.

**es**

Todos productos Ulf Moritz, Luzzus y Axxent pueden utilizarse en aplicaciones exteriores.

Instrucciones de instalación en la pág. 150 - 151.

Los productos deberán cubrirse con un revestimiento especial para su uso en el exterior.

**CONTACTEER ONS  
VOOR ADVIES**

**CONTACTEZ-NOUS  
POUR DES CONSEILS**

**CONTACT US FOR ADVISE**

**KONTAKTIEREN SIE UNS,  
FÜR BERATUNG**

**PÓNGASE EN CONTACTO CON  
NOSOTROS PARA RECIBIR  
MÁS INFORMACIÓN**

Inner corner | Binnenhoek | Coin intérieur | Innenecke | Esquina interna

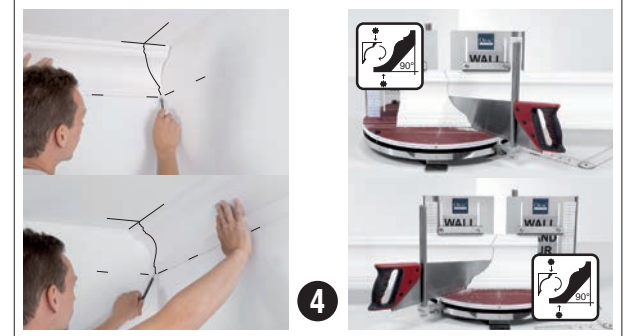
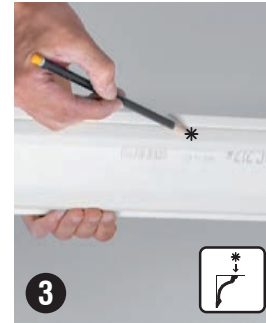
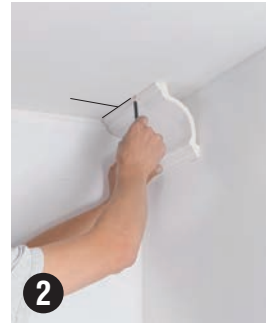

Outer corner | Buitenhoek | Coin extérieur | Aussenecke | Esquina externa

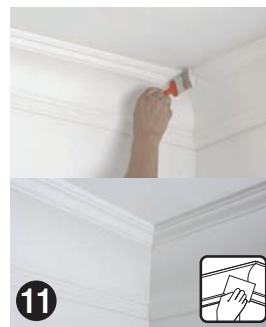
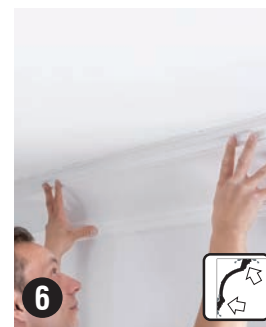
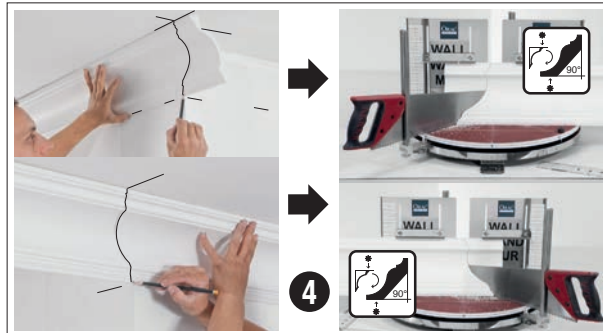

Stop mitre  
 Stopverstek  
 Arrêts  
 Verkrüpfung  
 Inglete de retorno

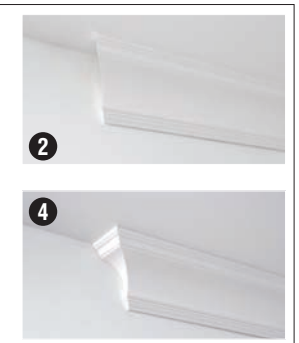

## Trefwoorden

Accessoires	148-153
Axent	62
Basixx	62
Brandvoorschriften	154
Buitentoepassingen	155
Byblos	134, 135
Consolen	147
DecoFix Extra	150, 151
DecoFix Hydro	150, 151
DecoFix Pro	150, 151
Decoratieve elementen	141-143
Deuromlijstingen	128-129
Deurpanelen	130
Dimmer	152, 153
Driver	152, 153
Durofoam®	63
Duropolymer®	63
Flexibele lijsten	98, 111, 117
Frontons	132
Garantie	150, 160
Hoeken voor wandlijsten	109, 110
Indirecte verlichting	118-124, 152-153
Installatie	156
Installatielijm	150, 151
Kapitelen	143-145
Koepels	140
Kroonlijsten	80-99
Lambrisering	108, 131
LED bars	152, 153
Lijm	150, 151
Lijmpistool	151
Luxxus	62
Nissen	133
Orac Flex	98, 111, 117
Panelen	130
Pilasters	146
Plafondtegels	140
Plinten	112-117
Polyurethaan	63
Project	154
Purotouch®	63
Rozassen	136-139
Schachten	143-145
Sierschouwen	133
Sokkels	128, 143-145
Ulf Moritz for Orac Decor®	62, 64-79
Variomatic	151
Verstekbakken	151
Wandverlichting	135
Wandlijsten	100-111
Zaag	151
Zuilen	143-145

## Mots Clés

Accessoires	148-153
Applications extérieures	155
Appliques	135
Axent	62
Basixx	62
Barres LED	152, 153
Basixx	62
Boîte à onglets	151
Byblos	134, 135
Chapiteaux	143-145
Cheminées décoratives	133
Cimaises	100-111
Coins pour cimaises	109, 110
Colle d'installation	150, 151
Colonnes	143-145
Consoles	147
Corniches	80-99
Coupoles	140
Dalles de plafond	140
DecoFix Extra	150, 151
DecoFix Hydro	150, 151
DecoFix Pro	150, 151
Durofoam®	63
Duropolymer®	63
Éclairage indirect	118-124, 152-153
Éléments décoratifs	141-143
Encadrements de portes	128-129
Frontons	132
Garantie	150, 160
Installation	156
Lambris	108, 131
Luxxus	62
Moulures flexibles	98, 111, 117
Niches	133
Normes anti-incendie	154
Orac Flex	98, 111, 117
Panneaux	130
Panneaux de portes	130
Pistolet à colle	151
Plinthes	112-117
Polyuréthane	63
Projets	154
Purotouch®	63
Rosaces	136-139
Scie	151
Socles	128, 143-145
Transfo	152, 153
Ulf Moritz for Orac Decor®	62, 64-79
Variateur	152, 153
Variomatic	151

## Key Words

Accessories	148-153
Adhesive	105, 151
Axent	62
Basixx	62
Byblos	134, 135
Capitals	143-145
Ceiling roses	136-139
Ceiling tiles	140
Columns	143-145
Contract	154
Corbels	147
Cornice mouldings	80-99
Deco elements	141-143
DecoFix Extra	150, 151
DecoFix Hydro	150, 151
DecoFix Pro	150, 151
Decorative mantel pieces	133
Dimming module	152, 153
Domes	140
Door frames	128-129
Door panels	130
Driver	152, 153
Durofoam®	63
Duropolymer®	63
Exterior applications	155
Fire retardant standards	154
Fixtures	135
Flexible mouldings	98, 111, 117
Glue	150, 151
Glue pistol	151
Guarantee	150, 160
Indirect lighting	118-124, 152-153
Installation	156
LED bars	152, 153
Luxxus	62
Mitre boxes	151
Niches	133
Orac Flex	98, 111, 117
Panel mouldings	100-111
Panelling	130
Panels moulding corners	109, 110
Pediments	132
Pilasters	146
Polyurethane	63
Purotouch®	63
Saw	151
Skirting boards	112-117
Socles	128, 143-145
Ulf Moritz for Orac Decor®	62, 64-79
Variomatic	151
Wainscoting	108, 131

## Schlüsselwörter

Armaturen	135
Außenverarbeitung	155
Axent	62
Basixx	62
Brandvorschriften	154
Byblos	134, 135
Deckenplatten	140
DecoFix Extra	150, 151
DecoFix Hydro	150, 151
DecoFix Pro	150, 151
Dekorative Kamine	133
Dimmer	152, 153
Durofoam®	63
Duropolymer®	63
Ecken mit Wandleisten	109, 110
Eckleisten	80-99
Flexible Leisten	98, 111, 117
Garantie	150, 160
Gehrungsladen	151
Indirekte Beleuchtung	118-124, 152-153
Installation	156
Kapitelle	143-145
Kleber	150, 151
Klebstoffpistole	151
Konsolen	147
Kuppeln	140
LED bars	152, 153
Luxxus	62
Nischen	133
Objekt	154
Orac Flex	98, 111, 117
Paneele	130
Pedimente	132
Pilaster	146
Polyurethan	63
Purotouch®	63
Rosetten	136-139
Säge	151
Säulen	143-145
Schaft	143-145
Socket	128, 143-145
Sockelleisten	112-117
Trafo	152, 153
Türpaneelle	130
Türumrandungen	128-129
Ulf Moritz for Orac Decor®	62, 64-79
Variomatic	151
Wand- und Friesleisten	100-111
Wandvertäfelung	108, 131
Zierelemente	141-143
Zubehör	148-153

## Palabras Clave

Accesorios	148-153
Aplicaciones para exterior	155
Aplicques para la pared	135
Axent	62
Bases	128, 143-145
Basixx	62
Byblos	134, 135
Capiteles	143-145
Chimeneas decorativas	133
Cola para la instalación	150, 151
Columnas	143-145
Cornisas	80-99
Cúpulas	140
DecoFix Extra	150, 151
DecoFix Hydro	150, 151
DecoFix Pro	150, 151
Durofoam®	63
Duropolymer®	63
Elementos de decoración	141-143
Frontales	132
Garantía	150, 160
Hornacinas	133
Iluminación indirecta	118-124, 152-153
Ingletadora	151
Instalación	156
LED bars	152, 153
Luxxus	62
Marcos para puertas	128-129
Ménsulas	147
Molduras	100-111
Molduras flexibles	98, 111, 117
Molduras para esquinas	109, 110
Normas ignifugas	154
Orac Flex	98, 111, 117
Panel de pared	130
Paneles	130
Paneles de puertas	130
Pilastras	146
Pistola para colas	151
Poliuretano	63
Proyectos	154
Purotouch®	63
Regulador gradual	152, 153
Rosetones	136-139
Sierra	151
Tejas del techo	140
Transformador	152, 153
Ulf Moritz for Orac Decor®	62, 64-79
Variomatic	151
Zócalos	112-117

<b>B</b>										<b>D</b>		<b>F</b>	
B401	147	C304   C304F	86	C362	121	CX101	95	D120	132	F10	140		
B404	147	C305	83	C364	121	CX106	96	D140	132	F11	140		
B408	147	C305 + C211	83	C370	67, 90	CX107	96	D161	132	F12	140		
B409	147	C305 + C213	83	C371	66, 125	CX108	94	D170	132	F30	130, 140		
B410	147	C307	90	C372	66, 125	CX109   CX109F	94	D200	128, 141	F31	140		
B413	147	C307 + C307A	90	C373   C373F	68, 123	CX110   CX110F	94	D210	128, 141				
B414	147	C308   C308F	91	C374   C374F	66, 123	CX111	93	D300	128, 134				
B417	147	C321   C321F	85	C400	83	CX112	94	D310	128, 134				
		C322   C322F	83	C402   C402F	85	CX115	93	D320	146				
		C331   C331F	83	C422	89	CX123	95	D330LR	128				
		C332	85, 91	C602   C602F	83	CX124   CX124F	94	D400	132				
		C333   C333F	86	C900	89, 125	CX126	95	D401	132				
		C334   C334F	88	C901   C901F	88, 125	CX127   CX127F	96	D402	132				
		C335	91, 160	C902   C902F	85, 125	CX128	96	D500	130				
		C336	91	C990	88, 90	CX129	96	D503	130				
		C337	89	C990 + 2x P9900	88, 90	CX132   CX132F	92, 114	D504	130				
		C338	89	C990 + P9900	88, 90	CX133	93, 114	D506	130				
		C338A	89	C990 + P9901	88, 90	CX134	108	D507	130				
		C338B	59, 89	C991	70, 86, 87, 125	CX136	95	D62	136, 141				
		C339   C339F	87	C991 + 2x P9900	86, 87	CX141	95	DX119-2300	104, 128				
		C340	86, 91	C991 + P9900	86, 87	CX142	95	DX121-2300	104, 128				
		C341   C341F	84	CB500	97	CX143	95	DX157-2300	92, 107, 114, 129				
		C342	87	CB501	97	CX148   CX148F	93	DX159-2300	92, 107, 114, 129				
		C343	90	CB502	97	CX149	93	DX162-2300	92, 106, 114, 129				
		C344	91	CB503	97	CX150	93	DX163-2300	92, 107, 115, 129				
		C351	120	CB510	97	CX151	94	DX168-2300	92, 107, 116, 129				
		C352	120	CB511	97	CX152	94						
		C353	82	CB512	97	CX153	94						
		C354	82, 99	CB520	97	CX154	93						
		C355	82	CB521	97	CX160	92						
		C356	82	CB522	97	CX161	92						
		C357	120	CB523	97								
		C358	120	CB530	97								
		C360	82	CB531	97								
		C361	121	CX100   CX100F	95								

<b>G</b>			
G40	141		
G42	141		
G70	72, 142		
G71	71, 143		
G72	72, 73, 142		
G73L	72, 142		
G73R	72, 142		
G74L	72, 142		
G74R	72, 142		
G75	71, 143		
G76	71, 143		
G77	72, 138, 142		
G78	72, 142		
GB02	147		
GB03	147		
GB04	147		

<b>H</b>			
H100A	133		
H100B	133		



H100C	133	K200	135, 146			P3071	67, 105	PX114	107	R46	138
H101A	133	K201	135, 146	<b>L</b>		P4020   P4020F	102, 109	PX116	106	R50	137
H101B	133	K201LR	146			P4020A	109	PX117	106	R52	138
<b>I</b>		K202	135, 146			P5020   P5020F	104, 109	PX120   PX120F	106, 110	R61	137
IL004-001	152, 153	K2131	145	L504	135	P5020B	109, 141	PX120A	110	R64	139
IL004-002	152, 153	K2132	144	L505	135	P5020B	109	PX131	106	R66	138
IL004-004	152, 153	K220	146			P5021   P5021F	102	PX144   PX144F	106	R70	71, 138
IL004-005	152, 153	K221	146	<b>M</b>		P5050	105	PX145	106	R73	139
IL004-006	152, 153	K223	146			P5051	103	PX146	107	R76	138
IL004-007	152, 153	K240	146	M9010A	134	P6020   P6020F	103	PX147	108, 131	R77	138
IL004-008	152, 153	K241	146	M9010B	134	P7010   P7010F	104	PX164	93, 108		
IL004-009	152, 153	K250	146	M9010C	134	P7020   P7020F	105	PX169	108, 131	<b>S</b>	
IL004-010	152, 153	K251	146	M9010LR	134	P7030   P7030F	104			SX104	116
IL004-013	152, 153	K253	146			P7040   P7040F	103	<b>R</b>		SX105   SX105F	115
		K254	146	<b>N</b>		P7070   P7070F	103	R07	136	SX118   SX118F	116
		K255	146			P7080	105	R08	136	SX122	114
		K3001	145	N503	133	P801C	109	R09	137	SX125	114
		K3002	144	N504	133	P8020   P8020F	103, 109	R10	136	SX137	115
<b>K</b>		K3101	145	N510	133	P8030   P8030F	102, 109	R11	136	SX138	116
K1001	145	K3102	144	N520	133	P8030C	109	R12	136	SX155   SX155F	115
K1002	144	K3111	145			P8030D	109, 110	R13	137	SX156	116
K1101	145	K3112	144	<b>P</b>		P8040   P8040F	104	R14	137	SX165   SX165F	114
K1102	144	K3141	145			P8050   P8050F	29, 105	R17	137	SX167	116, 122
K1102	144	K3142	144			P8060   P8060F	102	R18	137		
K1111	145	K3151	145	P101A	109	P9010	104, 128, 134	R22	139	<b>T</b>	
K1111	145	K3152	144	P1020   P1020F	102, 109	P9020   P9020F	104	R23	139	TF02	147
K1112	144	K3201	145	P20	109, 141	P9040   P9040F	102	R24	139		
K1121	145	K3202	144	P201A	109	P9050   P9050F	102	R27	139		
K1122	144	K4121	143	P2020   P2020F	102, 109	P9900   P9900F	103	R28	138		
K1131	145	K4122	143	P21	109, 141	P9901   P9901F	103	R31	137		
K1132	144	K4131	143	P3020   P3020F	103, 109	PB513	97	R35	136		
K1141	145	K4132	143	P3020A	109	PX102	107	R38	139		
K1142	144	KIT KX001	128	P3070	67, 105	PX103   PX103F	106, 110	R40	139		
K1151	145	KIT KX003	128			PX103A	110				
K1152	144					PX113	107				

Thanks to everybody who helped with the creation of this catalogue.

PROJECTS:

't Goude Hoofd, Intera /Gilbert Comhair - Rabo Bank, MEMO/Harry Karel - The Hamptons, Kissy Vandenplas - Berto , Winny Vangroenweghe - Pand 16, Cheops - Veerle de Niel - Lan Lan, Marisa Gallo - Casa Decor, Beatriz Silveira, Manuel Nuñez y Sergio Moreno, Guillermo Garcia-Hoz, Jean Porsche - Northsea Penthouse, Ann Gryp - House of Porters - Items Knokke - RR Interieur - 't Casteelken - Wildspirit

PHOTOGRAPHY BY

Verne Photography, Jürgen de Witte, [www.bartvanleuven.com](http://www.bartvanleuven.com)

REGISTERED CTM DESIGN N°

C335/000995576-0001 - C336/1035273-0001 - C337/1810706-0001 - C338/1978214-0001 - C338A/002341727-0007 - C338B/002341727-0006 - C339/1978214-0002 - C340/1978214-0003 - C341/002524769-0001 - C342/002524769-0002 - C343/002524769-0003 - C344/002524769-0004 - C351/000257464-0003 - C352/000257464-0004 - C353/000257464-0005 - C354/000257464-0006 - C355/000257464-0007 - C356/000257464-0008 - C361/1890526-0001 - C362/1890526-0002 - C363/1890526-0003 - C364/1890526-0004 - C370/2088880-0001 - C371/2088880-0002 - C372/2088880-0003 - C373/002524769-0005 - C374/002524769-0006 - C990/000995576-0002 - C991/002524769-0007 - CB500/1035273-0006 - CB501/1035273-0005 - CB502/1035273-0007 - CB503/1890526-0005 - CB510/1035273-000 - CB511/1035273-0003 - CB512/1890526-0007 - CB523/1035273-0002 - CB530/1890526-0008 - CB531/1890526-0009 - CX160/1790163-001 - CX161/1790163-0002 - D330/002524769-0013 - DX159-2300/1790163-0003 - DX162-2300/1790163-0004 - DX163-2300/1790163-0005 - DX168-2300/002341727-0004 - DX170-2300/002524769-0008 - G70/002158089-0001 - G71/002158089-0002 - G72/002158089-0003 - G73/002158089-0004 - G75/002524769-0009 - G76/002524769-0010 - G77/002524769-0011 - G78/002524769-0012 - P3020A/002341727-0005 - P3070/2088880-0004 - P3071/2088880-0005 - P5050/000257464-0001 - P5051/000257464-0002 - P8050/000995576-0003 - P8060/1810706-0002 - P9900/000995576-0004 - P9901/000995576-0005 - PB513/1890526-0006 - PX147/002341727-0003 - PX164/1790163-0006 - PX169/002341727-0002 - R70/2088880-0006 - SX156/000995576-0006 - SX165/002341727-0001 - SX167/2088880-0007

Guarantee terms and conditions apply if provided installation instructions have been followed to the letter.

Fire retardant standards. In many interiors and projects strict fire regulations are imposed. Therefore, ORAC has implemented a number of solutions depending on the country and its regulations. Please contact us for more information.

The information in this catalogue is without engagement. Changes and discrepancies in sizes or/and shapes against those stated in the catalogue can occur.

This catalogue and the design embodied within are protected by copyright law and international treaties. Unauthorized reproduction of the catalogue, any portion of it or the reproduction of the designs embodied therein may result in severe civil and criminal penalties and will be prosecuted to the maximum. Further legal information can be found on: [www.oracdecor.com/nl/disclaimer](http://www.oracdecor.com/nl/disclaimer).

All rights reserved. ©2014, ORAC nv

Concept & Graphics by King of Hearts and Gazeuse.be



*Reflecting*  
your  
*Imagination*

**ORAC HEADQUARTERS**

**NV ORAC SA**

Biekorfstraat 32,  
8400 Ostend, BELGIUM  
T +32 (0)59 80 32 52  
F +32 (0)59 80 28 10  
info@oracdecor.com

**ORAC NEDERLAND**

T 0800-022 2125  
F 0800-022 2138  
nederland@oracdecor.com

**ORAC FRANCE**

T 0800-900 358  
F +32 (0)59 80 28 10  
france@oracdecor.com

**ORAC DEUTSCHLAND**

T 0800-181 3694  
F +32 (0)59 34 05 24  
deutschland@oracdecor.com

**ORAC (UK) LTD**

City Business Centre  
6 Brighton Road, Unit 8  
Horsham RH13 5BB - UK  
uk@oracdecor.com

**ORAC SLOVAKIA S.R.O.**

Kpt. Nalepku 6  
SK-08271 Lipany  
T +421 (0)514-891 581  
F +421 (0)514-573 595  
slovakia@oracdecor.com

**ORAC SPAIN**

T 900 99 32 89  
F +32 (0)59 80 28 10  
espana@oracdecor.com